

Brochure

AC servo motors BSM Series



With expertise, and a comprehensive portfolio of products and life-cycle services, we help value-minded industrial customers improve their energy efficiency and productivity.

AC servo motors

Table of contents

BSM N-series	1
BSM C-series	2
SSBSM-series	3
BSM25/33 series	4
Engineering information	5
ABB motion product	6

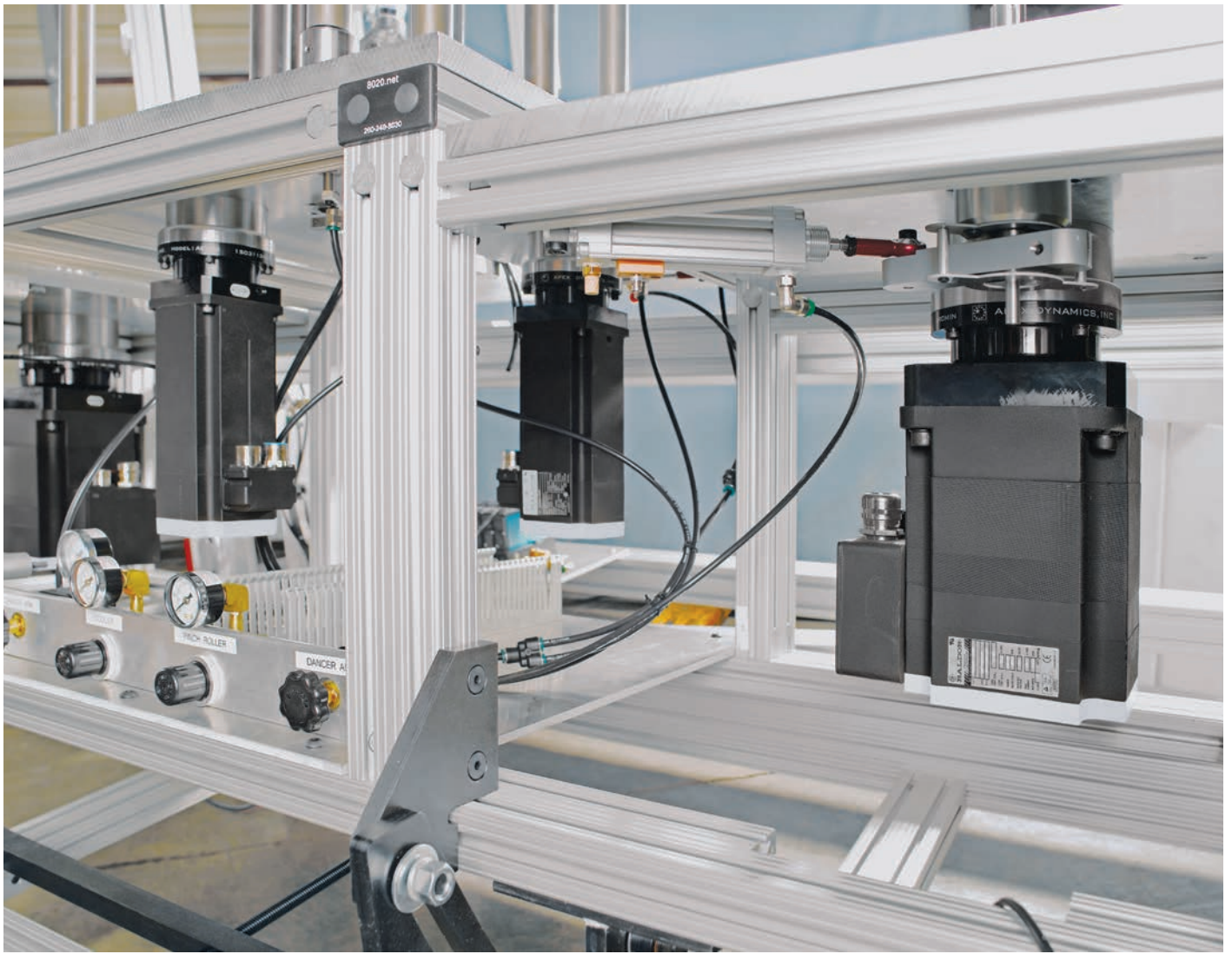

Introduction to Motion Control and PLC products

Solutions

ABB's comprehensive range includes multi-axis Motion Controllers, high performance Motion Control Drives, rotary servo motors, PLCs and HMI - all designed to seamlessly interface with each other to provide a complete motion solution. This allows you to optimize your design time, save development costs and minimize your time to market.

Choice

ABB firmly believes in offering our customers a range of products to fit a variety of market needs. Whether this means delivering a product from stock, designing a product for your specific application, accessing technical data, or how you place your order, we make it easy to do business with us. Our products are designed to handle a wide range of applications.

Quality, reliability & design

With ISO9001:2008 certification to assure conformity to customer requirements and quality standards, and by using the latest CAD tools and manufacturing techniques, ABB's engineering teams work side-by-side through design, product development, manufacture and final test to make sure that total quality and reliability is built into and stays with each product throughout its long lifetime.

Experience

Technical knowledge is the key to solving customers' needs. Our extensive experience has been gained over many years through close customer contact from product development to field maintenance, providing invaluable feedback for our product development process - ensuring ABB Motion Control and PLC products meet the ease of use, flexibility and performance demanded by the markets we serve. Application notes reflecting our knowledge and ability are available for download on the web at www.abb.com/motion.

Information

Information must be comprehensive and easily accessed. To make it easier for our customers, we provide a complete range of product literature as well as a website dedicated to Motion Control products - www.abb.com/motion. This brings together, in one location, all the information relevant to Motion Control and PLC products and includes technical information, latest news, application stories, application notes and support.



9AKK106417
Servo Motor Catalog



3AUA0000117576
MicroFlex e150 Flyer

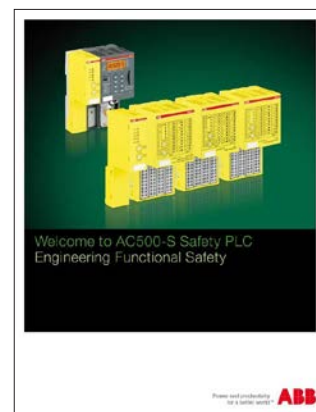

PLC-PHTB01U-EN
AC500-S Safety PLC Engineering Functional Safety Brochure

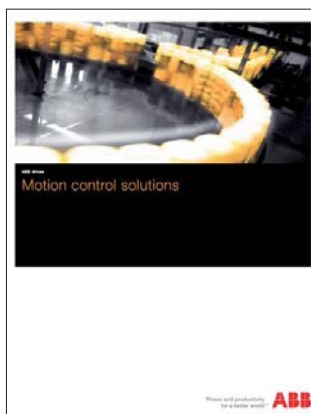

3AUA0000117593
Motion Control Solutions Brochure



3AUA0000168683
MotiFlex e180 Catalog

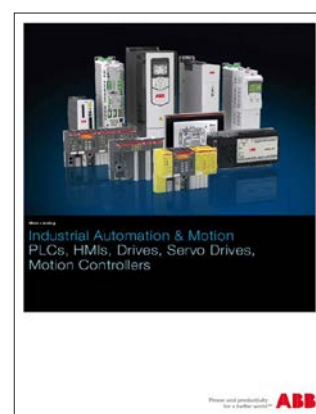

PLC-PHTC02U-EN
Industrial Automation Catalog

AC servo motors

BSM N-Series brushless servo motors

Low inertia - high dynamics

The BSM N series provides the lowest inertia and a high torque designed for excellent performance response. This series has a rugged, durable industrial design and is constructed with Neodymium Iron Boron magnetics. It is capable of peak torques equal to four times continuous, which can be used to provide high acceleration torques in applications. ABB BSM motors are available with a wide variety of feedback devices to suit application needs. IEC and NEMA configurations are available.



Variety of feedback options:

- Resolver
- Incremental/Absolute Encoders
- Hall sensors

Precision wrapped rotor

High acceleration capability - to move faster, to get the job done faster. High torque to inertia ratio - enables your machine to produce more parts per hour.

Moisture/Dust resistant o-rings

Environmentally rugged - for reliability and long life.

High temperature operation

Over temperature protection thermal switch. Heavy duty continuous operation - for dependable performance.



Cooling kits available on some models - to obtain more performance and extend torque range.
Optional holding brakes available.
Typical BSM63/80 series shown

Motor family	Size		Torque range	
	mm	in	lb-in	Nm
BSM50	55	2.1	3.9-12	0.45-1.36
BSM63	67	2.6	6.8-18.5	0.7-2.09
BSM80	89	3.5	14.6-40	1.6-4.5
BSM90	120	4.7	53-117	6-13.3
BSM100	146	5.7	123-354	14-40

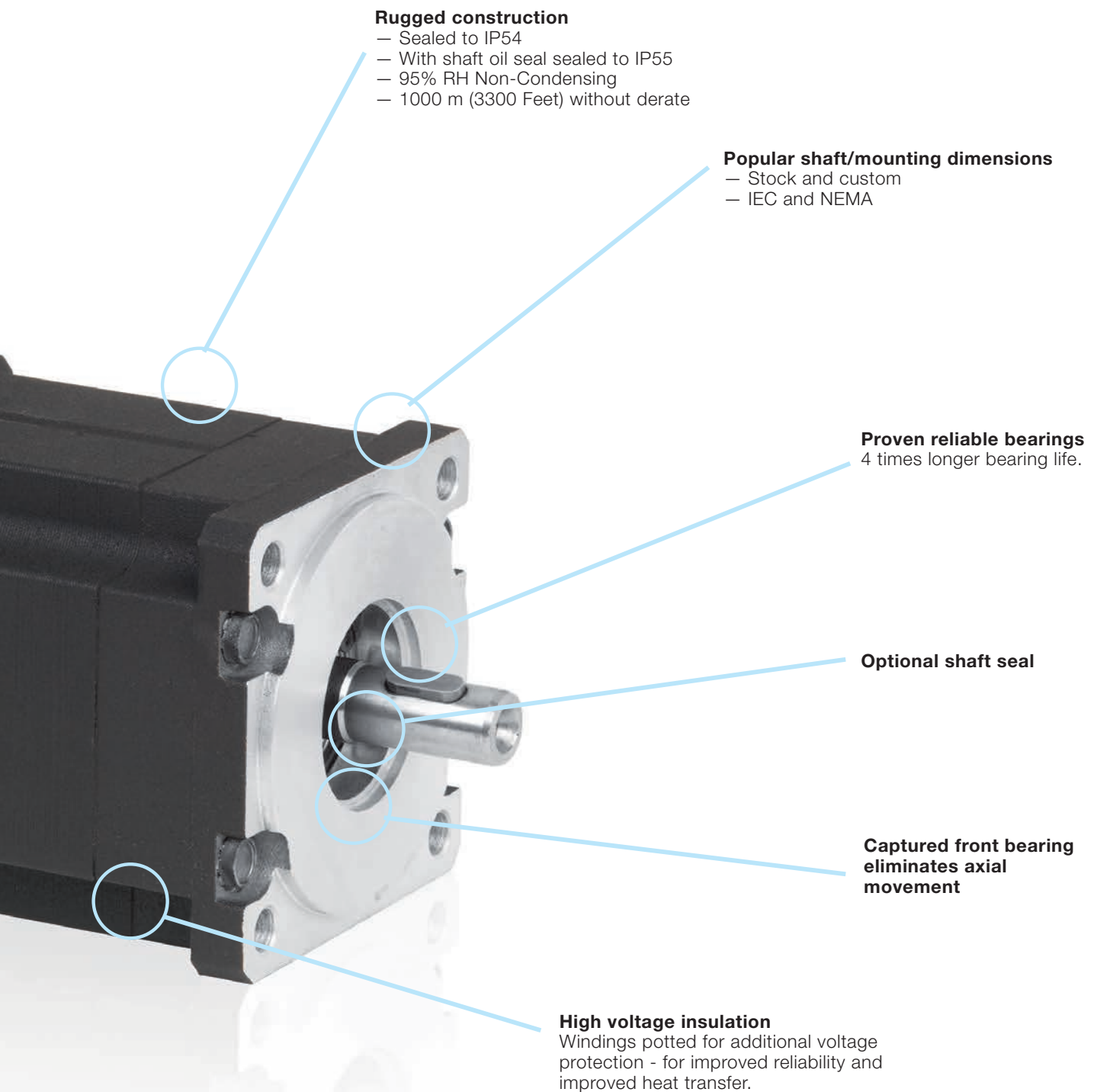

Rugged construction

- Sealed to IP54
- With shaft oil seal sealed to IP55
- 95% RH Non-Condensing
- 1000 m (3300 Feet) without derate

Popular shaft/mounting dimensions

- Stock and custom
- IEC and NEMA

Proven reliable bearings

4 times longer bearing life.

Optional shaft seal

Captured front bearing eliminates axial movement

High voltage insulation

Windings potted for additional voltage protection - for improved reliability and improved heat transfer.

AC servo motors

BSM N-series



The BSM N-series provides applications with low inertia to attain the highest acceleration capability - to position faster - to obtain the highest machine throughput. Our motors are hard at work, increasing productivity, improving part quality, providing precision and reducing cost in many applications. This series provides continuous stall torques ranging from 3.9 lb-in (0.4 Nm) to 354 lb-in (40 Nm). Peak torques are four times continuous. This series has the lowest inertia to provide the maximum torque per package size.

AC servo motors - N-series

Continuous stall torque		Continuous stall amps	Speed RPM @ 320V ¹	Motor number ²	Motor inertia	
lb-in	Nm				lb-in-s ²	Kg - cm ²
3.9	0.45	1.49	7500	BSM50N-133AX	0.00006	0.0677
		0.79	4000	BSM50N-175AX		
6.8	0.77	2.0	9000	BSM63N-133AX	0.00018	0.2031
		1.8	6000	BSM63N-150AX		
		1.0	4000	BSM63N-175AX		
7.9	0.9	2.8	7500	BSM50N-233AX	0.00011	0.125
		1.4	3750	BSM50N-275AX		
12	1.36	4.5	7500	BSM50N-333AX	0.00016	0.180
		2.3	4000	BSM50N-375AX		
13	1.47	3.9	9000	BSM63N-233AX	0.00034	0.384
		2.8	6000	BSM63N-250AX		
		1.9	4000	BSM63N-275AX		
14.6	1.65	4.7	9000	BSM80N-133AX	0.00091	1.02
		3.0	6000	BSM80N-150AX		
		2.1	4000	BSM80N-175AX		
18.5	2.0	6.0	9000	BSM63N-333AX	0.0005	0.564
		4.0	6000	BSM63N-350AX		
		2.8	4000	BSM63N-375AX		
28.3	3.2	8.7	9000	BSM80N-233AX	0.00162	1.82
		5.6	6000	BSM80N-250AX		
		3.9	4000	BSM80N-275AX		
40	4.52	12.9	9000	BSM80N-333AX	0.00223	2.519
		8.6	6000	BSM80N-350AX		
		5.5	4000	BSM80N-375AX		
53	6	7.8	4000	BSM90N-175AX	0.0030	3.389
		4.0	2000	BSM90N-1150AX		
		2.6	1200	BSM90N-1250AX		
88	10	11.6	4000	BSM90N-275AX	0.0056	6.327
		6.1	2000	BSM90N-2150AX		
		4.1	1200	BSM90N-2250AX		
117	13.3	19	4000	BSM90N-375AX	0.0082	9.264
		8.6	2000	BSM90N-3150AX		
		5.5	1200	BSM90N-3250AX		
123	14	9.4	2000	BSM100N-1150AX	0.0120	13.558
		5.9	1200	BSM100N-1250AX		
203	23	15.5	2000	BSM100N-2150AX	0.0196	22.145
		9.9	1200	BSM100N-2250AX		
300	34	21.0	2000	BSM100N-3150AX	0.0273	30.844
		14.7	1200	BSM100N-3250AX		
354	40	26.9	2000	BSM100N-4150AX	0.0349	39.431
		16.8	1200	BSM100N-4250AX		

Note: ¹ Nominal rpm shown at 320 Vdc bus for convenience. For 640 Vdc double the speed. Reference motor table to verify that max speed is not exceeded.

² For X callout, see motor ID matrix under engineering information.

AC servo motors

BSM N-series performance curves

BSM50N-133

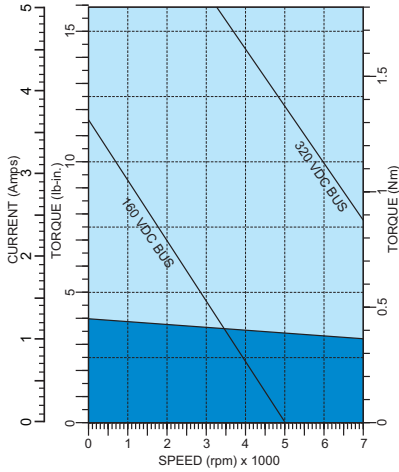

BSM50N-175

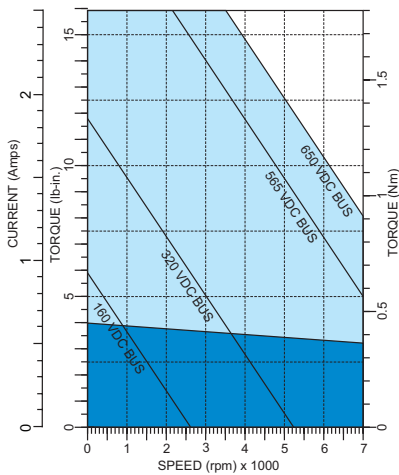

BSM50N-233

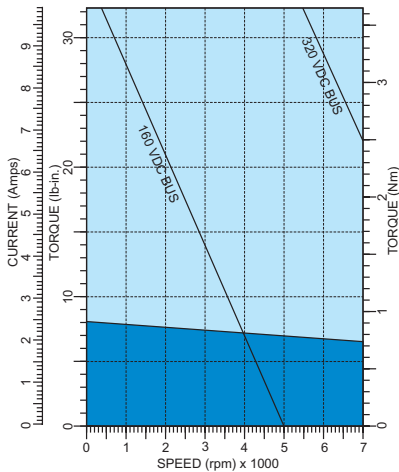

Model number		BSM50N-133	BSM50N-175	BSM50N-233
General				
Continuous stall torque	lb-in	3.9	3.9	7.9
	Nm	0.45	0.45	0.9
Continuous current	amps	1.49	0.79	2.87
Peak torque	lb-in	15.9	15.9	32.3
	Nm	1.8	1.8	3.65
Peak current	amps	5	2.52	9.91
Thermal resistance	°C/watt	3	3	2.6
Thermal time constant	Min	7	7	11
Mechanical time constant	msec	0.6	0.6	0.38
Electrical time constant	msec	1.3	1.3	2.1
Rated speed @ 300 volts	rpm	7500	4000	7500
Rated speed @ 160 volts	rpm	4000	1000	4000
Electrical				
Torque constant	lb-in/amp	3.14	6.31	3.25
	Nm/amp	0.35	0.71	0.36
Voltage constant	Vpk/krpm	30.37	60.94	32
	Vrms/krpm	21.48	43.1	22.7
Resistance	ohms	11.95	47.5	4
Inductance	mH	16.5	63.5	8.3
Mechanical				
Inertia	lb-in-s ²	0.00006	0.00006	0.00011
	Kg-cm ²	0.0677	0.0677	0.124
Maximum speed (1)	rpm	10,000	10,000	10,000
Number of motor poles	—	4	4	4
Weight	lbs/Kg	2.4/1.1	2.4/1.1	3.4/1.6

(1) Maximum speed can be limited by bus volts and feedback types.

AC servo motors

BSM N-series performance curves

1

BSM50N-275

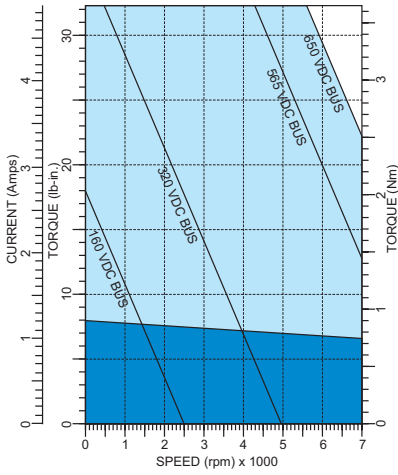

BSM50N-333

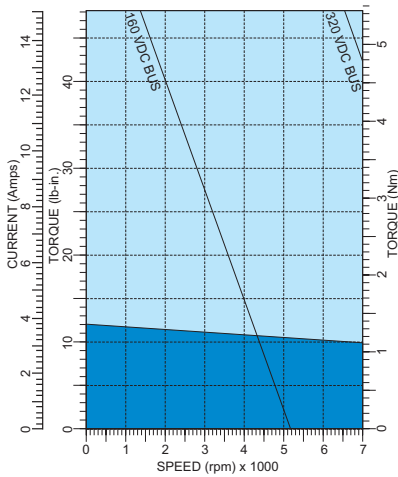

BSM50N-375

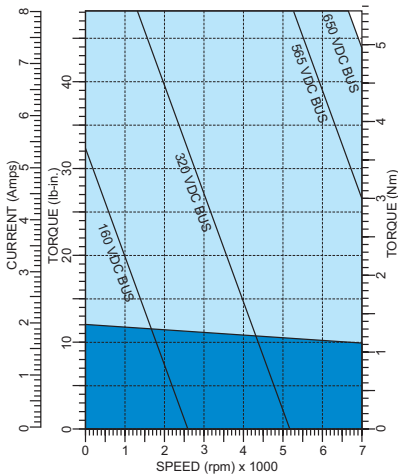

Model number		BSM50N-275	BSM50N-333	BSM50N-375
General				
Continuous stall torque	lb-in	7.9	12	12
	Nm	0.9	1.36	1.36
Continuous current	amps	1.42	4.56	2.38
Peak torque	lb-in	32	48.15	48.15
	Nm	3.65	5.44	5.44
Peak current	amps	4.87	15	8
Thermal resistance	°C/watt	2.6	1.8	1.8
Thermal time constant	Min	11	15	15
Mechanical time constant	msec	0.35	0.29	0.3
Electrical time constant	msec	2.1	1.9	1.8
Rated speed @ 300 volts	rpm	4000	7500	4000
Rated speed @ 160 volts	rpm	2000	4000	1500
Electrical				
Torque constant	lb-in/amp	6.66	3.2	6.4
	Nm/amp	0.75	0.36	0.72
	Vpk/krpm	64.3	30.9	61.9
Voltage constant	Vrms/krpm	45.5	21.89	43.8
	ohms	16	2.1	8.5
Inductance	mH	33.2	4.1	16
Mechanical				
Inertia	lb-in-s ²	0.00011	0.00016	0.00016
	Kg-cm ²	0.124	0.18	0.18
Maximum speed (1)	rpm	10,000	10,000	10,000
Number of motor poles	—	4	4	4
Weight	lbs/Kg	3.4/1.6	4.4/2	4.4/2

(1) Maximum speed can be limited by bus volts and feedback types.

AC servo motors

BSM N-series performance curves

BSM63N-133

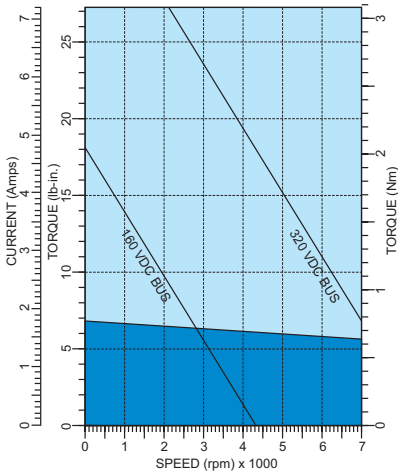

BSM63N-150

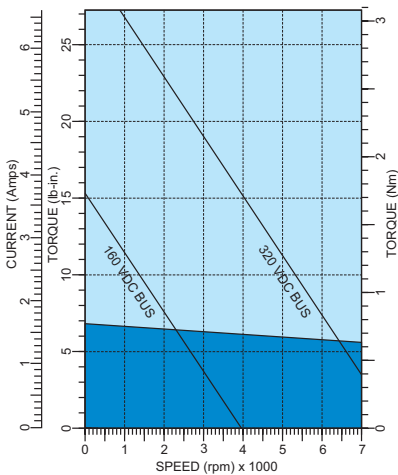

BSM63N-175

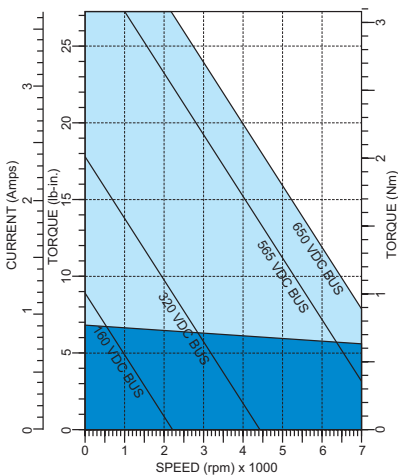

Model number		BSM63N-133	BSM63N-150	BSM63N-175
General				
Continuous stall torque	lb-in	6.8	6.8	6.8
	Nm	0.77	0.77	0.77
Continuous current	amps	2.01	1.83	1.01
Peak torque	lb-in	27.25	27.25	27.25
	Nm	3.08	3.08	3.08
Peak current	amps	7.24	6.59	3.64
Thermal resistance	°C/watt	2.2	2.2	2.2
Thermal time constant	Min	13	1.3	13
Mechanical time constant	msec	1	1.1	1
Electrical time constant	msec	1.5	2	2.1
Rated speed @ 300 volts	rpm	9000	6000	4000
Rated speed @ 160 volts	rpm	4000	3200	2130
Electrical				
Torque constant	lb-in/amp	3.75	4.12	7.46
	Nm/amp	0.425	0.467	0.844
Voltage constant	Vpk/krpm	36.3	39.9	72.1
	Vrms/krpm	25.7	28.2	51
Resistance	ohms	9.4	12.1	37.4
Inductance	mH	12.77	17.2	53.63
Mechanical				
Inertia	lb-in-s ²	0.00018	0.00018	0.00018
	Kg-cm ²	0.2031	0.2031	0.2031
Maximum speed (1)	rpm	10,000	10,000	10,000
Number of motor poles	—	4	4	4
Weight	lbs/Kg	3.7/1.68	3.7/1.68	3.7/1.68

(1) Maximum speed can be limited by bus volts and feedback types.

AC servo motors

BSM N-series performance curves

1

BSM63N-233

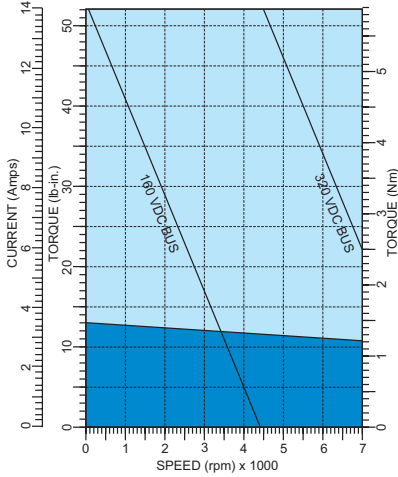

BSM63N-250

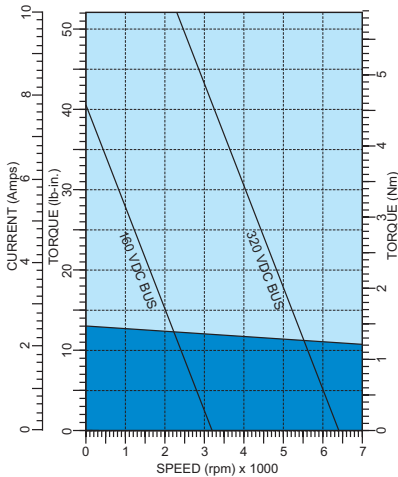

BSM63N-275

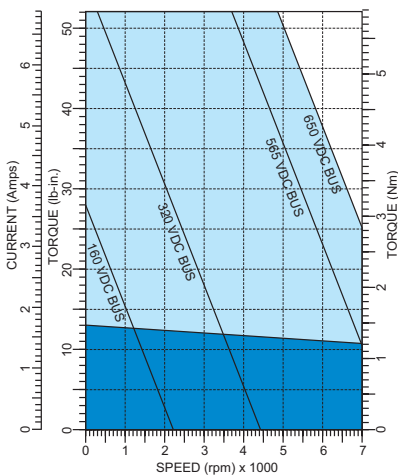

Model number		BSM63N-233	BSM63N-250	BSM63N-275
General				
Continuous stall torque	lb-in	13	13	13
	Nm	1.47	1.47	1.47
Continuous current	amps	3.93	2.82	1.94
Peak torque	lb-in	52.04	52.04	52.04
	Nm	5.88	5.88	5.88
Peak current	amps	14.1	10.1	6.96
Thermal resistance	°C/watt	1.9	1.9	1.9
Thermal time constant	Min	19	19	19
Mechanical time constant	msec	0.69	0.64	0.62
Electrical time constant	msec	1.5	2	2.1
Rated speed @ 300 volts	rpm	9000	6000	4000
Rated speed @ 160 volts	rpm	4800	3200	2130
Electrical				
Torque constant	lb-in/amp	3.67	5.12	7.47
	Nm/amp	0.415	0.579	0.844
	Vpk/krpm	35.4	49.4	72.1
Voltage constant	Vrms/krpm	25	34.9	51
	ohms	3.1	5.6	11.6
Resistance	mH	4.75	11.57	24.77
Mechanical				
Inertia	lb-in-s ²	0.00034	0.00034	0.00034
	Kg-cm ²	0.384	0.384	0.384
Maximum speed (1)	rpm	10,000	10,000	10,000
Number of motor poles	—	4	4	4
Weight	lbs/Kg	5/2.3	5/2.3	5/2.3

(1) Maximum speed can be limited by bus volts and feedback types.

AC servo motors

BSM N-series performance curves

BSM63N-333

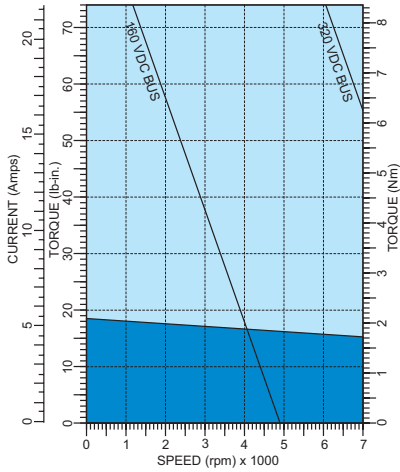

BSM63N-350

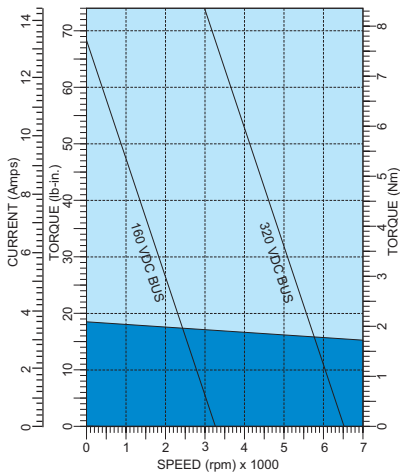

BSM63N-375

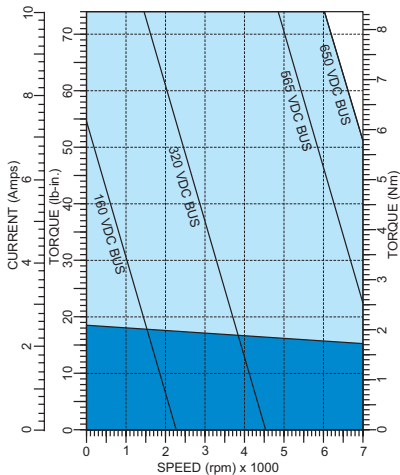

Model number		BSM63N-333	BSM63N-350	BSM63N-375
General				
Continuous stall torque	lb-in	18.5	18.5	18.5
	Nm	2.09	2.09	2.09
Continuous current	amps	6.03	4.05	2.82
Peak torque	lb-in	73.99	73.99	73.99
	Nm	8.36	8.36	8.36
Peak current	amps	21.7	14.5	10.1
Thermal resistance	°C/watt	1.6	1.6	1.6
Thermal time constant	Min	25	25	25
Mechanical time constant	msec	0.57	0.57	0.5
Electrical time constant	msec	1.9	1.79	2.3
Rated speed @ 300 volts	rpm	9000	6000	4000
Rated speed @ 160 volts	rpm	4800	3200	2130
Electrical				
Torque constant	lb-in/amp	3.41	5.07	7.28
	Nm/amp	0.385	0.573	0.823
Voltage constant	Vpk/krpm	32.8	49	70.2
	Vrms/krpm	23.25	34.6	49.7
Resistance	ohms	1.5	3.28	5.92
Inductance	mH	2.85	5.87	13.67
Mechanical				
Inertia	lb-in-s ²	0.0005	0.0005	0.0005
	Kg-cm ²	0.564	0.564	0.564
Maximum speed (1)	rpm	10,000	10,000	10,000
Number of motor poles	—	4	4	4
Weight	lbs/Kg	6.3/2.9	6.3/2.9	6.3/2.9

(1) Maximum speed can be limited by bus volts and feedback types.

AC servo motors

BSM N-series performance curves

1

BSM80N-133

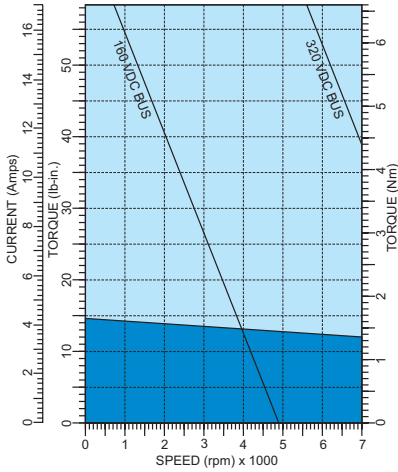

BSM80N-150

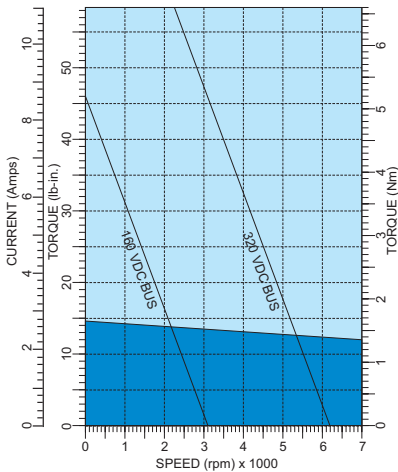

BSM80N-175

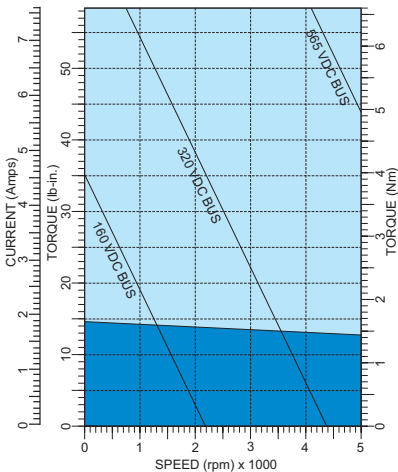

Model number		BSM80N-133	BSM80N-150	BSM80N-175
General				
Continuous stall torque	lb-in	14.6	14.6	14.6
	Nm	1.65	1.65	1.65
Continuous current	amps	4.74	3.05	2.14
Peak torque	lb-in	58.41	58.41	58.41
	Nm	6.6	6.6	6.6
Peak current	amps	17.1	11	7.69
Thermal resistance	°C/watt	1.84	1.84	1.84
Thermal time constant	Min	23	23	23
Mechanical time constant	msec	1.5	1.4	1.3
Electrical time constant	msec	2.4	2.7	2.9
Rated speed @ 300 volts	rpm		6000	4000
Rated speed @ 160 volts	rpm	4800	3200	2130
Electrical				
Torque constant	lb-in/amp	3.4	5.3	7.5
	Nm/amp	0.386	0.6	0.85
Voltage constant	Vpk/krpm	33.9	51.3	73.3
	Vrms/krpm	24.2	36.3	51.8
Resistance	ohms	2.1	5.1	9.53
Inductance	mH	5.2	13.97	28
Mechanical				
Inertia	lb-in-s ²	0.00091	0.00091	0.00091
	Kg-cm ²	1.02	1.02	1.02
Maximum speed	rpm	7,000	7,000	7,000
Number of motor poles	—	4	4	4
Weight	lbs/Kg	7/3.2	7/3.2	7/3.2

AC servo motors

BSM N-series performance curves

BSM80N-233

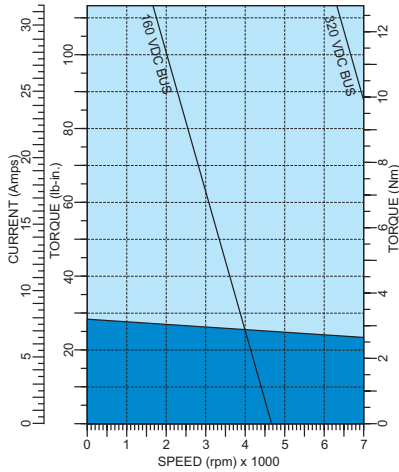

BSM80N-250

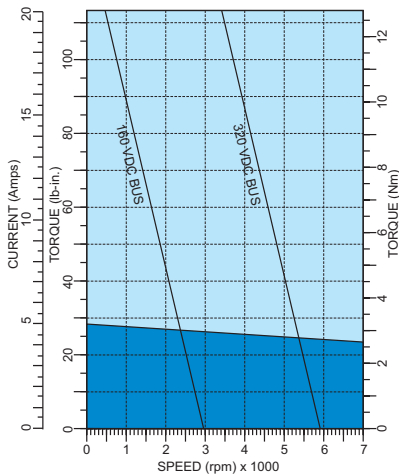

BSM80N-275

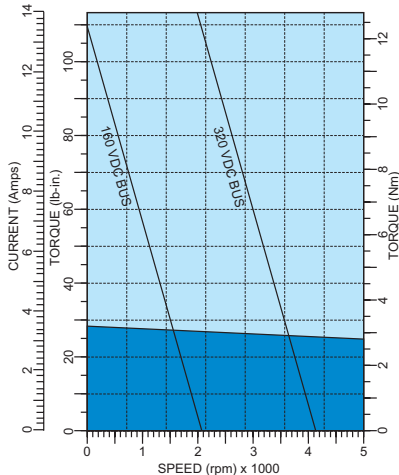

Model number		BSM80N-233	BSM80N-250	BSM80N-275
General				
Continuous stall torque	lb-in	28.3	28.3	28.3
	Nm	3.2	3.2	3.2
Continuous current	amps	8.76	5.61	4
Peak torque	lb-in	113.28	113.28	113.28
	Nm	12.8	12.8	12.8
Peak current	amps	31.5	20.2	14
Thermal resistance	°C/watt	1.5	1.5	1.5
Thermal time constant	Min	28	28	28
Mechanical time constant	msec	0.95	0.84	0.72
Electrical time constant	msec	3.2	2.9	3.9
Rated speed @ 300 volts	rpm		6000	4000
Rated speed @ 160 volts	rpm	4800	3200	2130
Electrical				
Torque constant	lb-in/amp	3.59	5.6	8
	Nm/amp	0.406	0.633	0.904
Voltage constant	Vpk/krpm	34.7	54.1	77.3
	Vrms/krpm	24.6	38.29	54.7
Resistance	ohms	0.832	1.81	3.2
Inductance	mH	2.73	5.3	12.73
Mechanical				
Inertia	lb-in-s ²	0.00162	0.00162	0.00162
	Kg-cm ²	1.82	1.82	1.82
Maximum speed	rpm	7,000	7,000	7,000
Number of motor poles	—	4	4	4
Weight	lbs/Kg	10/4.6	10/4.6	10/4.6

AC servo motors

BSM N-series performance curves

1

BSM80N-333

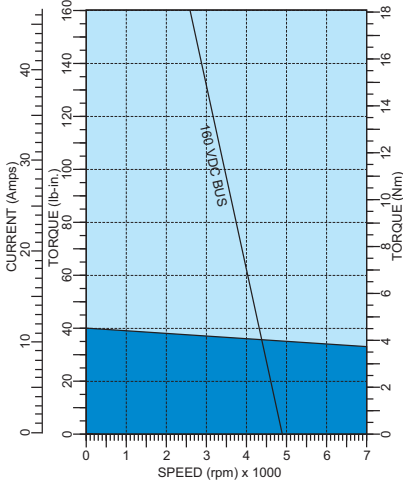

BSM80N-350

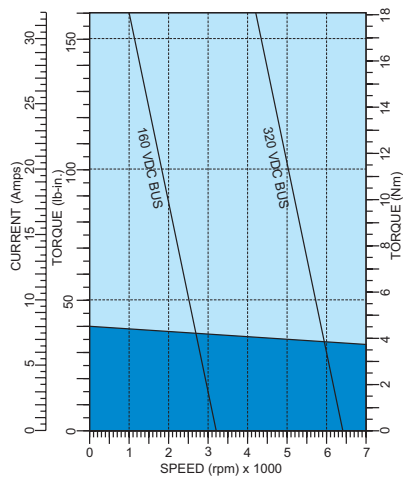

BSM80N-375

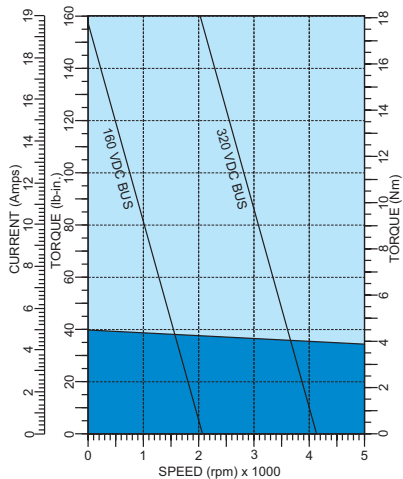

Model number		BSM80N-333	BSM80N-350	BSM80N-375
General				
Continuous stall torque	lb-in	40	40	40
	Nm	4.52	4.52	4.52
Continuous current	amps	12.98	8.61	5.54
Peak torque	lb-in	160	160	160
	Nm	18.08	18.08	18.08
Peak current	amps	46.71	31.01	19.96
Thermal resistance	°C/watt	1.22	1.22	1.22
Thermal time constant	Min	34	34	34
Mechanical time constant	msec	0.75	0.7	0.69
Electrical time constant	msec	3.9	4.3	4.2
Rated speed @ 300 volts	rpm		6000	4000
Rated speed @ 160 volts	rpm	4800	3200	2130
Electrical				
Torque constant	lb-in/amp	3.42	5.15	8.01
	Nm/amp	0.387	0.583	0.906
Voltage constant	Vpk/krpm	33.2	49.7	77.4
	Vrms/krpm	23.41	35.2	54.7
Resistance	ohms	0.433	0.935	2.22
Inductance	mH	1.7	4	9.3
Mechanical				
Inertia	lb-in-s ²	0.00223	0.00223	0.00223
	Kg-cm ²	2.519	2.519	2.519
Maximum speed	rpm	7,000	7,000	7,000
Number of motor poles	—	4	4	4
Weight	lbs/Kg	13/6	13/6	13/6

AC servo motors

BSM N-series performance curves

BSM90N-175

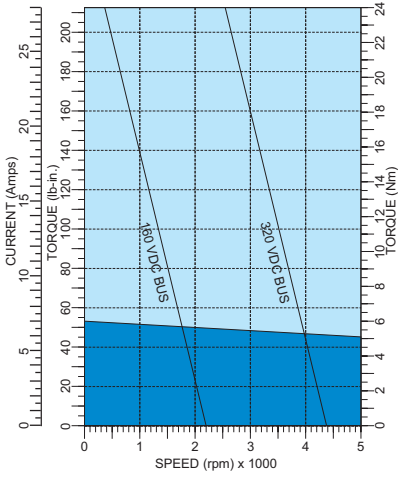

BSM90N-1150

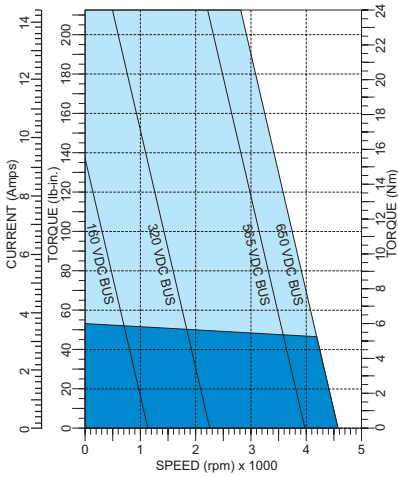

BSM90N-1250

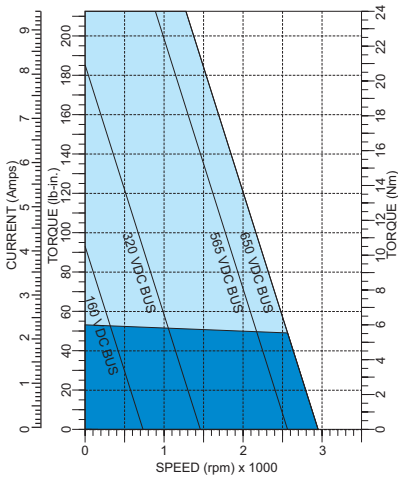

Model number		BSM90N-175	BSM90N-1150	BSM90N-1250
General				
Continuous stall torque	lb-in	53	53	53
	Nm	6	6	6
Continuous current	amps	7.8	4.03	2.6
Peak torque	lb-in	212.41	212.41	212.41
	Nm	24	24	24
Peak current	amps	28.1	14.5	9.37
Thermal resistance	°C/watt	1.16	1.16	1.16
Thermal time constant	Min	38	38	38
Mechanical time constant	msec	0.58	0.54	0.55
Electrical time constant	msec	3.3	4	4.1
Rated speed @ 300 volts	rpm	4000	2000	1200
Rated speed @ 600 volts	rpm		4000	2400
Electrical				
Torque constant	lb-in/amp	7.31	14.16	21.93
	Nm/amp	0.853	1.65	2.56
Voltage constant	Vpk/krpm	72.8	141.3	218.9
	Vrms/krpm	51.5	99.9	154.8
Resistance	ohms	1.24	4.33	10.66
Inductance	mH	4.15	17.6	43.5
Mechanical				
Inertia	lb-in-s ²	0.003	0.003	0.003
	Kg-cm ²	3.389	3.389	3.389
Maximum speed	rpm	7,000	7,000	7,000
Number of motor poles	—	8	8	8
Weight	lbs/Kg	18/8.2	18/8.2	18/8.2

AC servo motors

BSM N-series performance curves

1

BSM90N-275

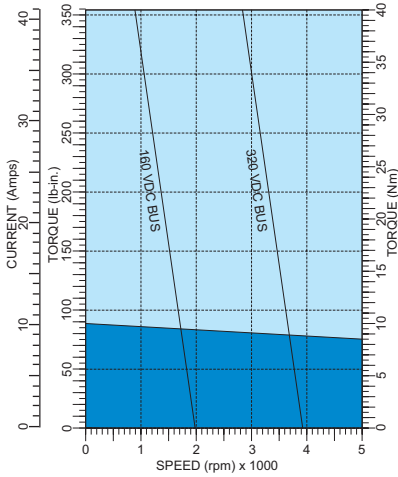

BSM90N-2150

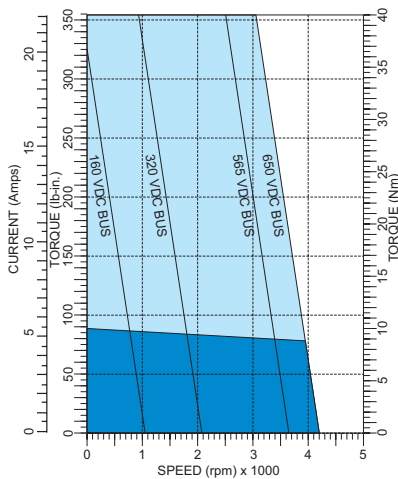

BSM90N-2250

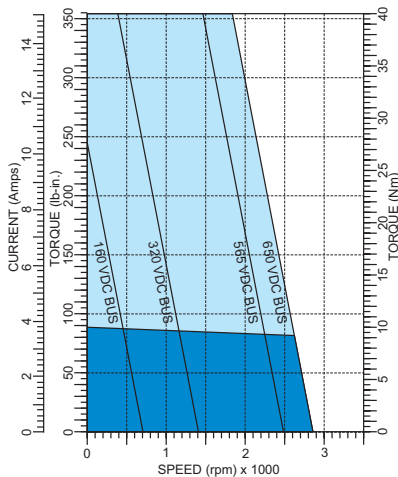

Model number		BSM90N-275 ¹	BSM90N-2150 ¹	BSM90N-2250 ¹
General				
Continuous stall torque	lb-in	88	88	88
	Nm	10	10	10
Continuous current	amps	11.6	6.15	4.19
Peak torque	lb-in	354	354	354
	Nm	40	40	40
Peak current	amps	41.8	22.1	15
Thermal resistance	°C/watt	1.15	1.15	1.15
Thermal time constant	Min	49	49	49
Mechanical time constant	msec	0.36	0.38	0.36
Electrical time constant	msec	5.1	5.4	5.7
Rated speed @ 300 volts	rpm	4000	2000	1200
Rated speed @ 600 volts	rpm		4000	2400
Electrical				
Torque constant	lb-in/amp	8.43	15.9	23.4
	Nm/amp	0.954	1.8	2.65
Voltage constant	Vpk/krpm	81.5	154.5	226.7
	Vrms/krpm	57.6	109.3	160.3
Resistance	ohms	0.523	1.97	3.94
Inductance	mH	2.66	10.5	22.5
Mechanical				
Inertia	lb-in-s ²	0.0056	0.0056	0.0056
	Kg-cm ²	6.327	6.327	6.327
Maximum speed	rpm	7,000	7,000	7,000
Number of motor poles	—	8	8	8
Weight	lbs/Kg	28/12.7	28/12.7	28/12.7

¹ A blower option is available which will increase the motor's continuous stall torque by another 80%.

AC servo motors

BSM N-series performance curves

BSM90N-375

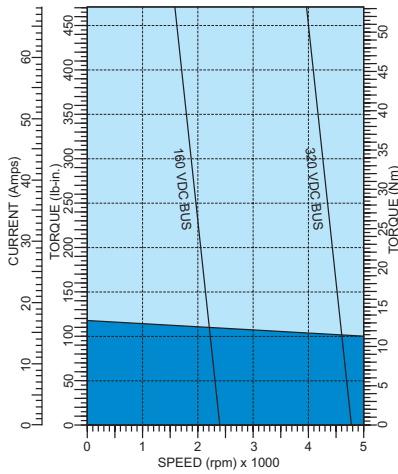

BSM90N-3150

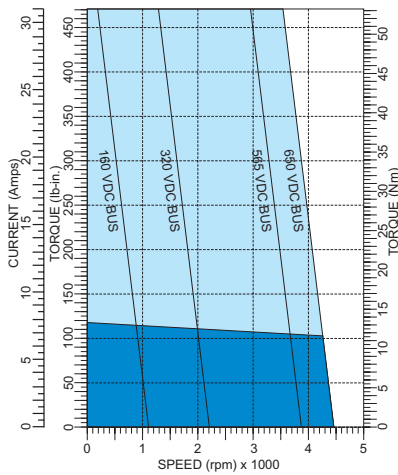

BSM90N-3250

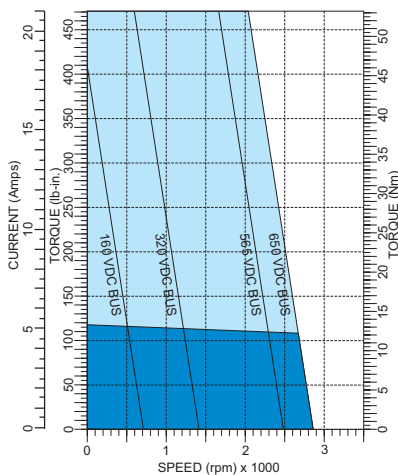

Model number		BSM90N-375 ¹	BSM90N-3150 ¹	BSM90N-3250 ¹
General				
Continuous stall torque	lb-in	117	117	117
	Nm	13.3	13.3	13.3
Continuous current	amps	19.01	8.64	5.59
Peak torque	lb-in	471	471	471
	Nm	53.2	53.2	53.2
Peak current	amps	68.47	31.1	20.1
Thermal resistance	°C/watt	1.14	1.14	1.14
Thermal time constant	Min	59	59	59
Mechanical time constant	msec	0.32	0.33	0.32
Electrical time constant	msec	2.8	5.4	5.5
Rated speed @ 300 volts	rpm	4000	2000	1200
Rated speed @ 600 volts	rpm		4000	2400
Electrical				
Torque constant	lb-in/amp	6.8	15.07	23.4
	Nm/amp	0.77	1.7	2.64
Voltage constant	Vpk/krpm	65.7	145.6	226.3
	Vrms/krpm	46.5	103	160.1
Resistance	ohms	0.2075	1.02	2.39
Inductance	mH	1.257	5.53	13.18
Mechanical				
Inertia	lb-in-s ²	0.0082	0.0082	0.0082
	Kg-cm ²	9.264	9.264	9.264
Maximum speed	rpm	7,000	7,000	7,000
Number of motor poles	—	8	8	8
Weight	lbs/Kg	38/17.3	38/17.3	38/17.3

¹ A blower option is available which will increase the motor's continuous stall torque by another 80%.

AC servo motors

BSM N-series performance curves

1

BSM100N-1150

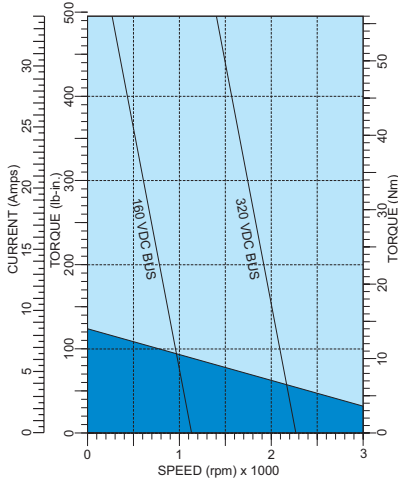

BSM100N-1250

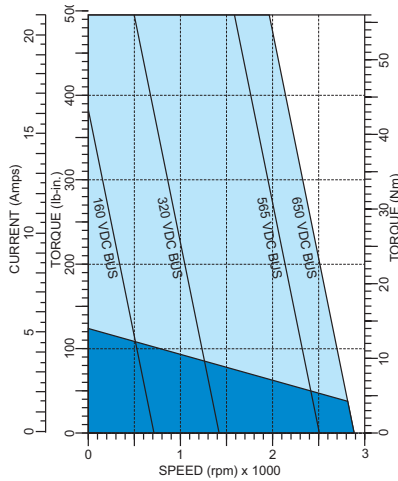

BSM100N-2150

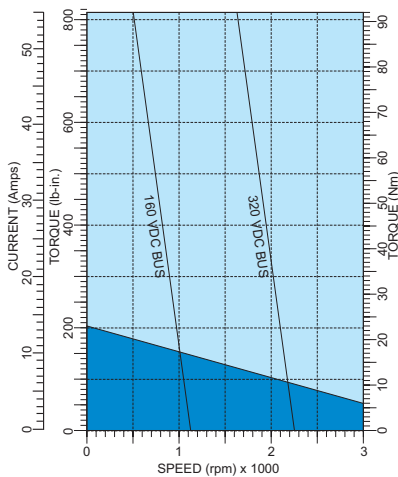

Model number		BSM100N-1150	BSM100N-1250	BSM100N-2150
General				
Continuous stall torque	lb-in	123.9	123.9	203.5
	Nm	14	14	23
Continuous current	amps	9.4	5.9	15.5
	Peak torque	lb-in	495.6	495.6
	Nm	56	56	92
Peak current	amps	34	21.2	55.8
Thermal resistance	°C/watt	1.05	1.05	1
Thermal time constant	Min	58	58	67
Mechanical time constant	msec	0.47	0.46	0.33
Electrical time constant	msec	7.2	7.4	8.3
Rated speed @ 300 volts	rpm	2000	1200	2000
Rated speed @ 160 volts	rpm	1000	640	1000
Electrical				
Torque constant	lb-in/amp	14.5	23.3	14.5
	Nm/amp	1.64	2.6	1.64
Voltage constant	Vpk/krpm	140.4	225.3	140.8
	Vrms/krpm	99.3	159.4	99.6
Resistance	ohms	0.91	2.25	0.4
Inductance	mH	6.6	17.5	3.3
Mechanical				
Inertia	lb-in-s ²	0.012	0.012	0.0196
	Kg-cm ²	13.558	13.558	22.145
Maximum speed	rpm	4,000	4,000	4,000
Number of motor poles	—	8	8	8
Weight	lbs/Kg	35/16	35/16	49/22.3

AC servo motors

BSM N-series performance curves

BSM100N-2250

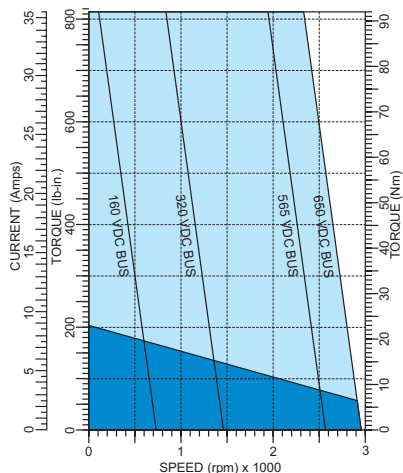

BSM100N-3150

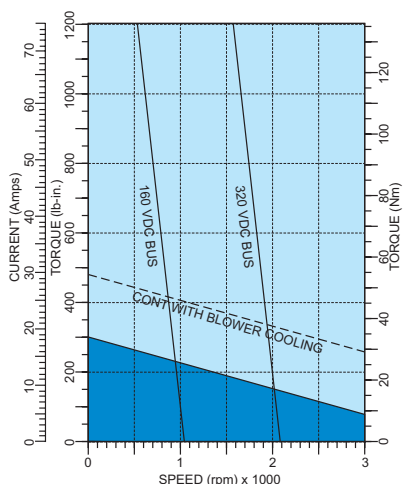

BSM100N-3250

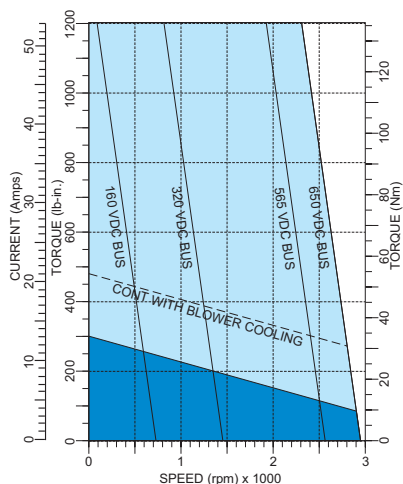

Model number		BSM100N-2250	BSM100N-3150 ¹	BSM100N-3250 ¹
General				
Continuous stall torque	lb-in	203.5	300	300
	Nm	23	34	34
Continuous current	amps	9.9	21	14.7
	Peak torque	lb-in	814.2	1203.6
	Nm	92	136	136
Peak current	amps	35.8	75.8	53.1
Thermal resistance	°C/watt	1	0.7	0.7
Thermal time constant	Min	67	76	76
Mechanical time constant	msec	0.3	0.24	0.29
Electrical time constant	msec	9.4	10.9	9.7
Rated speed @ 300 volts	rpm	1200	2000	1200
Rated speed @ 600 volts	rpm	2400		2400
Electrical				
Torque constant	lb-in/amp	22.6	15.8	22.6
	Nm/amp	2.56	1.79	2.56
Voltage constant	Vpk/krpm	219	153.1	218.8
	Vrms/krpm	154.9	108.3	154.7
Resistance	ohms	0.87	0.25	0.61
Inductance	mH	8.25	2.7	5.8
Mechanical				
Inertia	lb-in-s ²	0.0196	0.0273	0.0273
	Kg-cm ²	22.145	30.844	30.844
Maximum speed	rpm	4,000	4,000	4,000
Number of motor poles	—	8	8	8
Weight	lbs/Kg	49/22.3	63/28.6	63/28.6

¹ A blower option is available which will increase the motor's continuous stall torque by another 60%.

AC servo motors

BSM N-series performance curves

1

BSM100N-4150

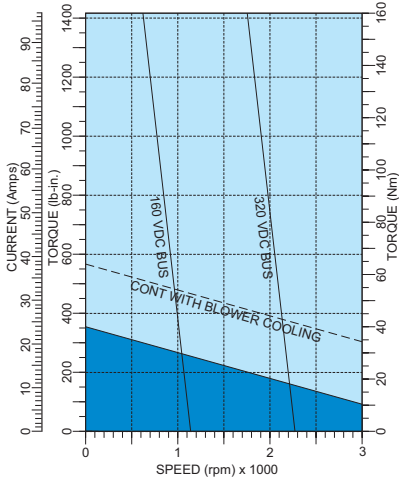

BSM100N-4250

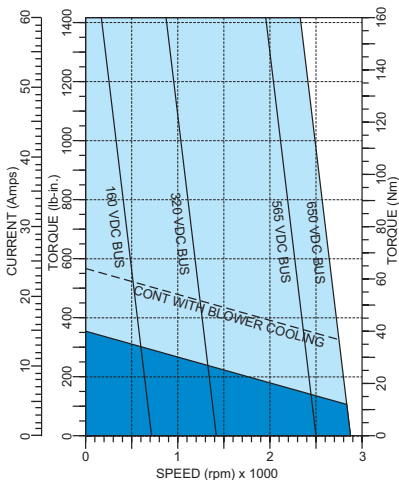

Model number		BSM100N-4150 ¹	BSM100N-4250 ¹
General			
Continuous stall torque	lb-in	354	354
	Nm	40	40
Continuous current	amps	26.9	16.8
Peak torque	lb-in	1416	1416
	Nm	160	160
Peak current	amps	97.1	60.7
Thermal resistance	°C/watt	0.66	0.66
Thermal time constant	Min	85	85
Mechanical time constant	msec	0.26	0.26
Electrical time constant	msec	10.3	10.5
Rated speed @ 300 volts	rpm	2000	1200
Rated speed @ 600 volts	rpm		2400
Electrical			
Torque constant	lb-in/amp	14.5	23.2
	Nm/amp	1.64	2.63
Voltage constant	Vpk/krpm	140.7	225.1
	Vrms/krpm	99.5	159.2
Resistance	ohms	0.18	0.46
Inductance	mH	1.867	4.86
Mechanical			
Inertia	lb-in-s ²	0.0349	0.0349
	Kg-cm ²	39.431	39.431
Maximum speed	rpm	4,000	4,000
Number of motor poles	—	8	8
Weight	lbs/Kg	77/35	77/35

¹ A blower option is available which will increase the motor's continuous stall torque by another 60%.

AC servo motors

Brushless servo C-series

The BSM C series of servo motors provide higher inertia in an economical package. These motors have a reliable magnetic design, and are used in applications needing higher inertial matching. These rugged motors provide peak torques equal to three times continuous, thus enabling rapid acceleration for the higher inertial demanding applications. Besides a wide variety of feedback devices, other options such as brakes, cooling to extend performance, mounting, shaft, and electrical windings are available for your application needs. We also have stocked motors for immediate delivery for your application needs.



Motor family	Size		Torque range	
	mm	in	lb-in	Nm
BSM80	89	3.5	10-38	1.2-4.3
BSM90	120	4.7	23-69	2.6-7.8
BSM100	146	5.7	44-265	5-30
BSM132	244	9.6	469-1185	53-134

Variety of feedback options:

- Resolver
- Incremental/Absolute Encoders
- Hall sensors

Stock and custom shafts and mountings. Rugged industrial construction - quality in the design

- IEC and NEMA
- Design interchangeable with N-Series - versatility for machine designs

High continuous rated operating temperature
Over temperature protective thermal switch

Optional holding brakes

O-rings for moisture and dust resistance
Rugged design for rugged environments - quality in the design.

Higher rotor inertia -
for matching heavier machine inertial loads.

High voltage insulation
Windings potted for additional voltage protection - for improved reliability and improved heat transfer

Proven reliable bearings
4 times longer bearing life

Rugged construction

- Sealed to IP54
- With shaft oil seal sealed to IP55
- 95% RH Non-Condensing
- 1000 m (3300 Feet) without derate

Optional shaft seal

Optional forced air cooling on some models - to extend torque capability for additional motor performance.
Typical BSM 90/100 series shown

AC servo motors

BSM C-series



The BSM C-series has as standard, a “higher” inertia - thus providing an excellent match for equipment requiring higher inertial matching for the machine. This series provides continuous stall capability ranging from 10 lb-In (1.2 Nm) to 1185 lb-In (134 Nm). Peak torques are typically three times continuous. The BSM C-series provides up to 50% more torque in a smaller size (2 inches/50 mm shorter) compared to previous models. The C-series provides an economical package best used in applications with higher load inertias.

2

AC servo motors - C-series

Continuous stall torque		Continuous stall amps	Speed RPM @ 320V ¹	Motor number ²	Motor inertia	
lb-in	Nm				lb-in-s ²	Kg - cm ²
10.6	1.2	2.7	6000	BSM80C-150AX	0.0016	1.81
		1.9	4000	BSM80C-175AX		
21.2	2.4	5.2	6000	BSM80C-250AX	0.0033	3.73
		3.2	4000	BSM80C-275AX		
		1.82	2000	BSM80C-2150AX		
23.0	2.6	2.1	2000	BSM90C-1150AX	0.0039	4.4
31.8	3.6	7.8	6000	BSM80C-350AX	0.0049	5.61
		6.3	4000	BSM80C-375AX		
		3.2	2000	BSM80C-3150AX		
38.0	4.3	6.3	4000	BSM80C-475AX	0.0066	7.45
		3.1	2000	BSM80C-4150AX		
		4.0	2400	BSM100C-1150AX		
2.3	1200	BSM100C-1250AX				
46.0	5.2	9.0	4000	BSM90C-275AX	0.0078	8.81
		4.7	2000	BSM90C-2150AX		
		2.5	1200	BSM90C-2250AX		
69.0	7.8	12.0	4000	BSM90C-375AX	0.0117	13.2
		6.0	2000	BSM90C-3150AX		
		3.4	1200	BSM90C-3250AX		
88.5	10.0	8.0	2400	BSM100C-2150AX	0.0299	33.7
		4.9	1200	BSM100C-2250AX		
125.7	14.2	11.4	2400	BSM100C-3150AX	0.0448	50.6
		6.9	1200	BSM100C-3250AX		
177.0	20.0	16.8	2400	BSM100C-4150AX	0.0598	67.5
		10.6	1200	BSM100C-4250AX		
221.3	25.0	21.0	2400	BSM100C-5150AX	0.0747	84.4
		13.0	1200	BSM100C-5250AX		
265.5	30.0	24.0	2000	BSM100C-6150AX	0.0897	101.2
		14.1	1200	BSM100C-6250AX		
469	53	37	1800	BSM132C-3200AX	0.233	262
619	70	43	1800	BSM132C-4200AX	0.287	324
770	87	50	1800	BSM132C-5200AX	0.345	389
929	105	52	1800	BSM132C-6200AX	0.392	443
1008	114	72	1800	BSM132C-7200AX	0.448	506
1097	124	74	1800	BSM132C-8200AX	0.513	579
1185	134	79	1800	BSM132C-9200AX	0.57	644

Note: ¹ Nominal rpm shown at 320 Vdc bus for convenience. For 640 Vdc double the speed. Reference motor table to verify that max speed is not exceeded.

² For X callouts, see motor ID matrix under engineering information.

AC servo motors

BSM C-series performance curves

BSM80C-150

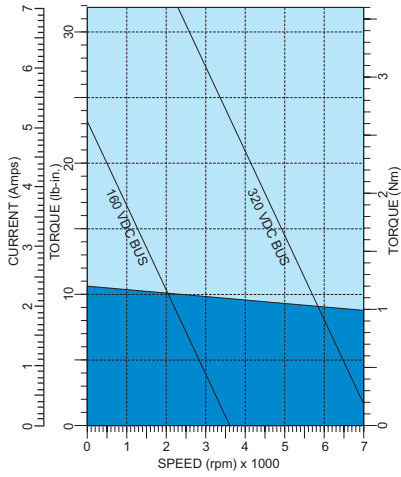

BSM80C-175

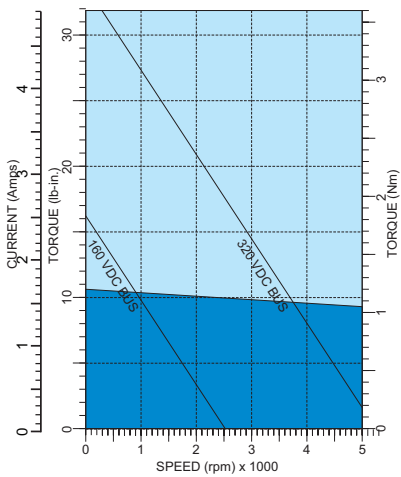

BSM80C-250

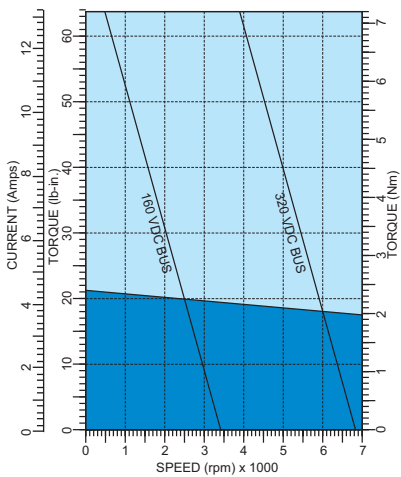

Model number		BSM80C-150	BSM80C-175	BSM80C-250
General				
Continuous stall torque	lb-in	10.6	10.6	21.2
	Nm	1.2	1.2	2.4
Continuous current	amps	2.75	1.93	5.2
Peak torque	lb-in	31.9	31.9	63.7
	Nm	3.6	3.6	7.2
Peak current	amps	7	4.9	13.3
Thermal resistance	°C/watt	1.33	1.33	1.15
Thermal time constant	Min	19	19	23
Mechanical time constant	msec	5.95	5.96	3.59
Electrical time constant	msec	1.63	1.65	2.79
Rated speed @ 300 volts	rpm	6000	4000	6000
Rated speed @160 volts	rpm	3200	2130	3200
Electrical				
Torque constant	lb-in/amp	4.5	6.5	4.8
	Nm/amp	0.51	0.73	0.54
Voltage constant	Vpk/krpm	43.7	62.5	46.2
	Vrms/krpm	30.9	44.2	32.7
Resistance	ohms	8.6	17.6	2.8
Inductance	mH	14	29.1	7.8
Mechanical				
Inertia	lb-in-s ²	0.0016	0.0016	0.0033
	Kg-cm ²	1.81	1.81	3.73
Maximum speed (1)	rpm	10,000	10,000	10,000
Number of motor poles	—	4	4	4
Weight	lbs/Kg	9/4.1	9/4.1	10/4.5

(1) Maximum speed can be limited by bus volts and feedback types.

AC servo motors

BSM C-series performance curves

BSM80C-275

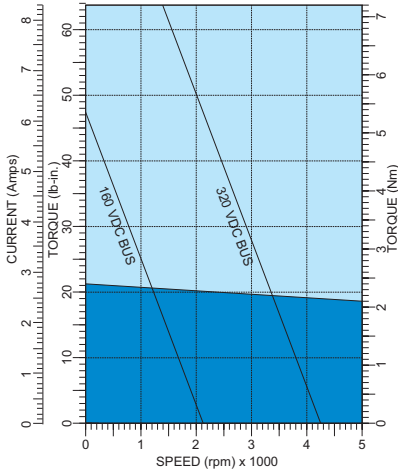

BSM80C-2150

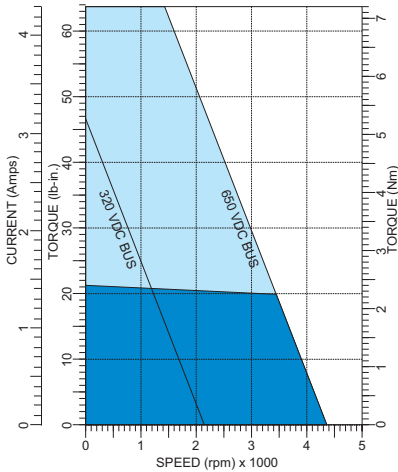

BSM80C-350

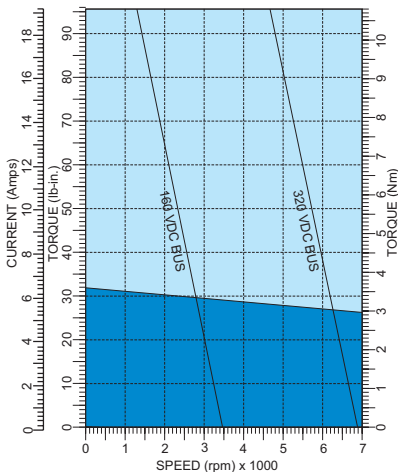

Model number		BSM80C-275	BSM80C-2150	BSM80C-350
General				
Continuous stall torque	lb-in	21.2	21.2	31.9
	Nm	2.4	2.4	3.6
Continuous current	amps	3.24	1.82	7.8
	lb-in	63.7	63.7	95.6
Peak torque	lb-in	63.7	63.7	95.6
	Nm	7.2	7.2	10.8
Peak current	amps	8.3	4.3	19.3
Thermal resistance	°C/watt	1.15	1.15	1
Thermal time constant	Min	23	23	28
Mechanical time constant	msec	3.54	3.59	2.63
Electrical time constant	msec	2.63	2.81	3.02
Rated speed @ 300 volts	rpm	4000	2000	6000
Rated speed @ 600 volts	rpm	8000	4000	
Electrical				
Torque constant	lb-in/amp	7.7	14.5	4.8
	Nm/amp	0.87	1.64	0.54
Voltage constant	Vpk/krpm	74.5	140.4	46.2
	Vrms/krpm	52.7	99.3	32.7
Resistance	ohms	7.2	26.6	1.39
Inductance	mH	18.9	73.3	4.2
Mechanical				
Inertia	lb-in-s ²	0.0033	0.0033	0.00497
	Kg-cm ²	3.73	3.73	5.53
Maximum speed (1)	rpm	10,000	10,000	10,000
Number of motor poles	—	4	4	4
Weight	lbs/Kg	10/4.5	10/4.5	11/5.0

(1) Maximum speed can be limited by bus volts and feedback types.

AC servo motors

BSM C-series performance curves

BSM80C-375

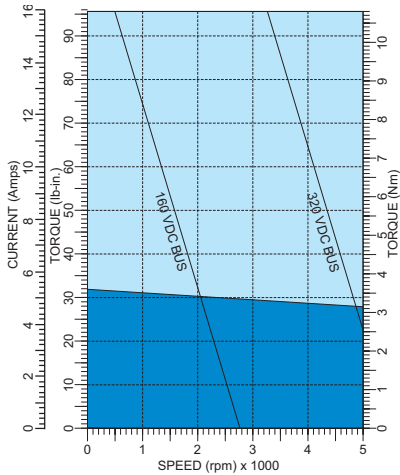

BSM80C-3150

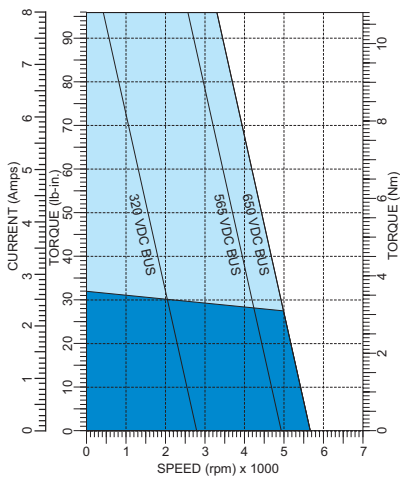

BSM80C-475

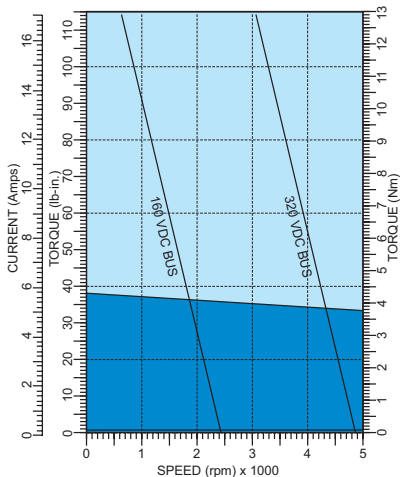

Model number		BSM80C-375	BSM80C-3150	BSM80C-475
General				
Continuous stall torque	lb-in	31.9	31.9	38.1
	Nm	3.6	3.6	4.3
Continuous current	amps	6.29	3.2	6.3
	lb-in	95.6	95.6	114.2
Peak torque	Nm	10.8	10.8	12.9
	amps	16	8.1	17
Peak current	amps	16	8.1	17
Thermal resistance	°C/watt	1	1	1
Thermal time constant	Min	28	28	32
Mechanical time constant	msec	2.7	2.7	2.42
Electrical time constant	msec	3.73	3.69	3.16
Rated speed @ 300 volts	rpm	4000	2000	4000
Rated speed @ 600 volts	rpm	8000	4000	8000
Electrical				
Torque constant	lb-in/amp	6	11.8	6.7
	Nm/amp	0.67	1.33	0.76
Voltage constant	Vpk/krpm	57.5	113.8	65.05
	Vrms/krpm	40.7	80.5	46
	ohms	2.2	8.9	1.95
Inductance	mH	8.2	32.8	6
Mechanical				
Inertia	lb-in-s ²	0.00497	0.00497	0.0066
	Kg-cm ²	5.53	5.53	7.45
Maximum speed (1)	rpm	10,000	10,000	10,000
Number of motor poles	—	4	4	4
Weight	lbs/Kg	11/5.0	11/5.0	16/7.2

(1) Maximum speed can be limited by bus volts and feedback types.

AC servo motors

BSM C-series performance curves

BSM80C-4150

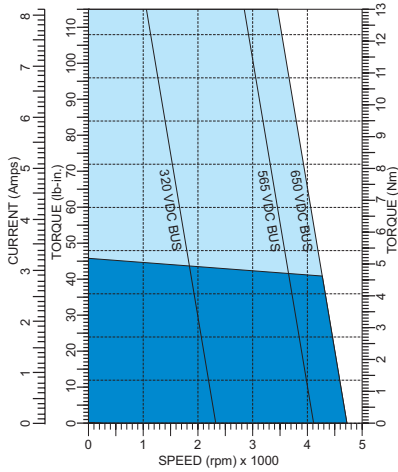

BSM90C-1150

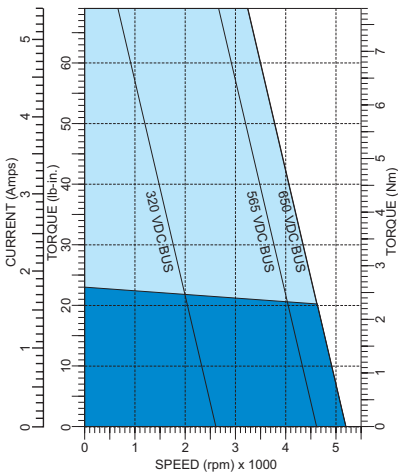

BSM90C-275

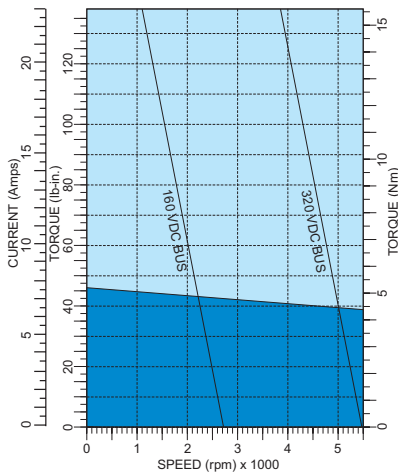

Model number		BSM80C-4150	BSM90C-1150	BSM90C-275
General				
Continuous stall torque	lb-in	38.1	23	46
	Nm	4.3	2.6	5.2
Continuous current	amps	3.17	2.15	9
Peak torque	lb-in	114.2	69	138.1
	Nm	12.9	7.8	15.6
Peak current	amps	8.1	5.47	23
Thermal resistance	°C/watt	1	1.6	0.9
Thermal time constant	Min	32	35	45
Mechanical time constant	msec	2.03	2.52	1
Electrical time constant	msec	3.93	2.4	3.56
Rated speed @ 300 volts	rpm	2000	2000	4000
Rated speed @ 600 volts	rpm	4000	4000	8000
Electrical				
Torque constant	lb-in/amp	14.1	12.6	6
	Nm/amp	1.59	1.42	0.68
Voltage constant	Vpk/krpm	136.5	121.8	57.9
	Vrms/krpm	96.5	86.1	41.0
Resistance	ohms	7	11.5	1.04
Inductance	mH	27.5	27.6	3.7
Mechanical				
Inertia	lb-in-s ²	0.0066	0.0039	0.0078
	Kg-cm ²	7.45	4.4	8.81
Maximum speed (1)	rpm	10,000	10,000	10,000
Number of motor poles	—	4	8	8
Weight	lbs/Kg	16/7.2	17/7.7	23/10.5

(1) Maximum speed can be limited by bus volts and feedback types.

AC servo motors

BSM C-series performance curves

BSM90C-2150

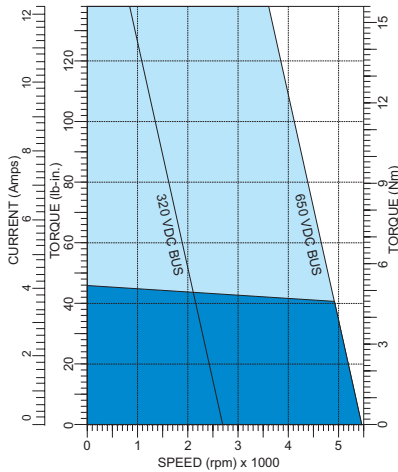

BSM90C-2250

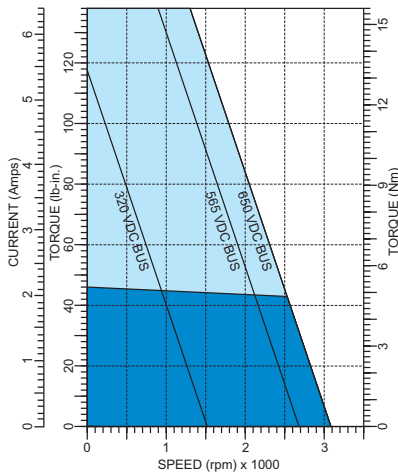

BSM90C-375

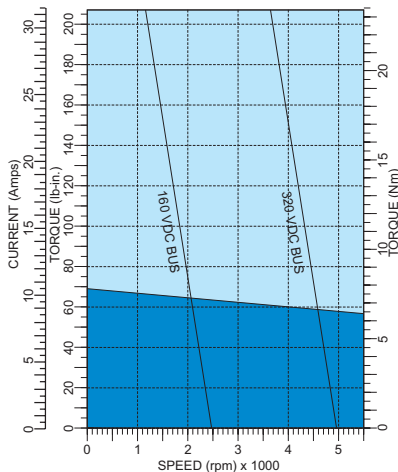

Model number		BSM90C-2150	BSM90C-2250	BSM90C-375
General				
Continuous stall torque	lb-in	46	46	69
	Nm	5.2	5.2	7.8
Continuous current	amps	4.78	2.51	12
Peak torque	lb-in	138.1	138.1	207.1
	Nm	15.6	15.6	23.4
Peak current	amps	12.2	6.4	30.8
Thermal resistance	°C/watt	0.9	0.9	0.87
Thermal time constant	Min	45	45	55
Mechanical time constant	msec	2.32	2.38	1.59
Electrical time constant	msec	2.96	3.29	3.84
Rated speed @ 300 volts	rpm	2000	1200	4000
Rated speed @ 600 volts	rpm	4000	2400	8000
Electrical				
Torque constant	lb-in/amp	12.2	21.6	6.7
	Nm/amp	1.38	2.44	0.76
Voltage constant	Vpk/krpm	118.8	208.6	64.9
	Vrms/krpm	84	147.5	45.9
Resistance	ohms	5	16	0.69
Inductance	mH	14.8	52.7	2.65
Mechanical				
Inertia	lb-in-s ²	0.0078	0.0078	0.0117
	Kg-cm ²	8.81	8.81	13.21
Maximum speed	rpm	7,000	7,000	7,000
Number of motor poles	—	8	8	8
Weight	lbs/Kg	23/10.5	23/10.5	30/13.6

AC servo motors

BSM C-series performance curves

BSM90C-3150

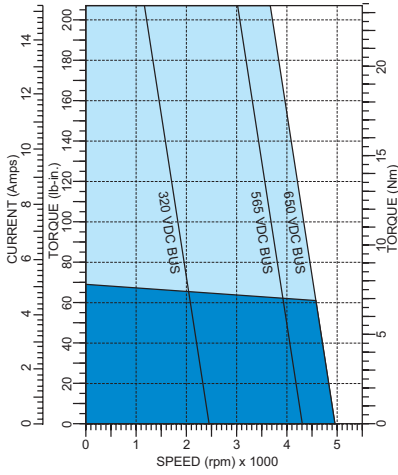

BSM90C-3250

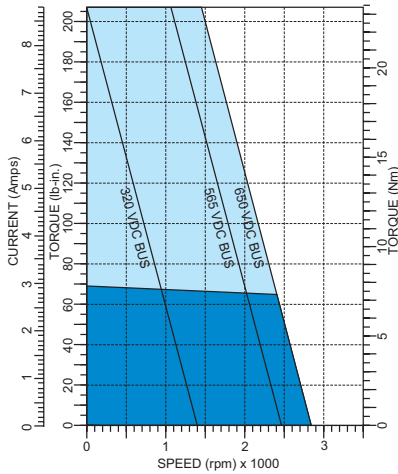

BSM90C-4150

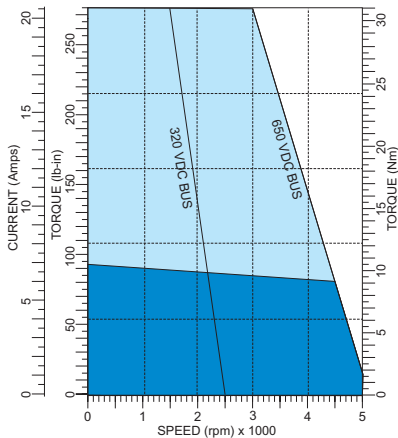

Model number		BSM90C-3150	BSM90C-3250	BSM90C-4150
General				
Continuous stall torque	lb-in	69	69	92.0
	Nm	7.8	7.8	10.4
Continuous current	amps	6	3.45	7.69
Peak torque	lb-in	207.1	207.1	276.1
	Nm	23.4	23.4	31.2
Peak current	amps	15.4	8.8	20.8
Thermal resistance	°C/watt	0.87	0.87	0.45
Thermal time constant	Min	55	55	57
Mechanical time constant	msec	1.55	1.84	2.00
Electrical time constant	msec	4.22	3.32	4.44
Rated speed @ 300 volts	rpm	2000	1200	2000
Rated speed @ 600 volts	rpm	4000	2400	4000
Electrical				
Torque constant	lb-in/amp	13.4	23.5	13.3
	Nm/amp	1.52	2.65	1.50
Voltage constant	Vpk/krpm	129.8	227.1	128
	Vrms/krpm	91.8	160.6	90.8
Resistance	ohms	2.7	9.77	1.5
Inductance	mH	11.4	32.4	6.6
Mechanical				
Inertia	lb-in-s ²	0.0117	0.0117	0.0156
	Kg-cm ²	13.21	13.21	17.67
Maximum speed	rpm	7,000	7,000	7,000
Number of motor poles	—	8	8	8
Weight	lbs/Kg	30/13.6	30/13.6	36/16.3

AC servo motors

BSM C-series performance curves

BSM100C-1150

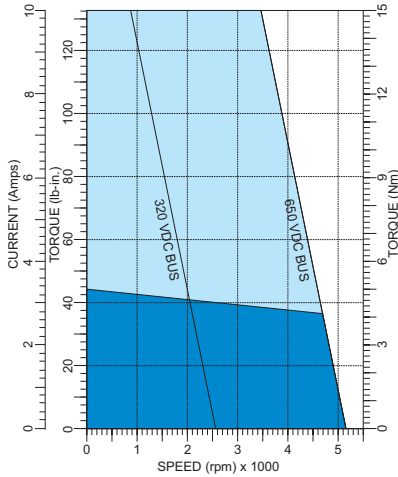

BSM100C-1250

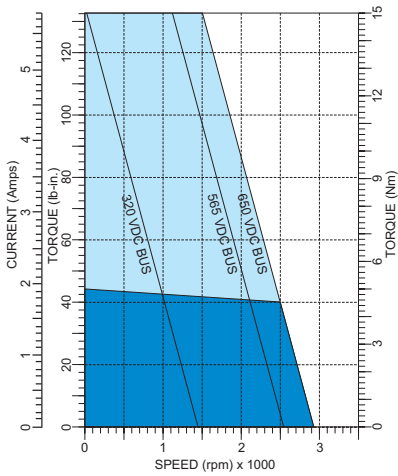

BSM100C-2150

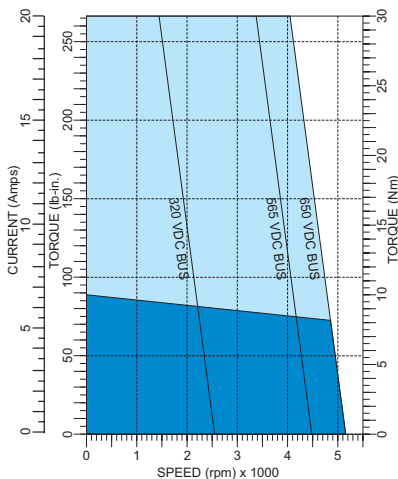

Model number		BSM100C-1150	BSM100C-1250	BSM100C-2150
General				
Continuous stall torque	lb-in	44.3	44.3	88.5
	Nm	5	5	10
Continuous current	amps	4.01	2.3	8.02
Peak torque	lb-in	132.8	132.8	265.5
	Nm	15	15	30
Peak current	amps	10.2	5.8	20.4
Thermal resistance	°C/watt	1.04	1.04	0.84
Thermal time constant	Min	47	47	54
Mechanical time constant	msec	4.12	3.71	2.54
Electrical time constant	msec	3.69	4.12	5.13
Rated speed @ 300 volts	rpm	2400	1200	2400
Rated speed @ 600 volts	rpm	4800	2400	4800
Electrical				
Torque constant	lb-in/amp	12.9	22.7	12.9
	Nm/amp	1.46	2.57	1.46
Voltage constant	Vpk/krpm	125	219.9	125
	Vrms/krpm	88.4	155.5	88.4
Resistance	ohms	5.2	14.5	1.6
Inductance	mH	19.2	59.8	8.2
Mechanical				
Inertia	lb-in-s ²	0.0149	0.0149	0.02991
	Kg-cm ²	16.82	16.82	33.77
Maximum speed	rpm	7,000	7,000	7,000
Number of motor poles	—	8	8	8
Weight	lbs/Kg	30/13.6	30/13.6	39/17.7

AC servo motors

BSM C-series performance curves

BSM100C-2250

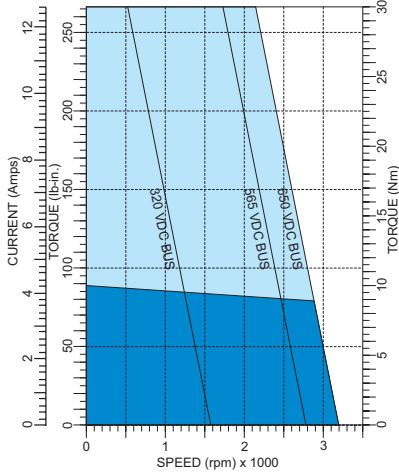

BSM100C-3150

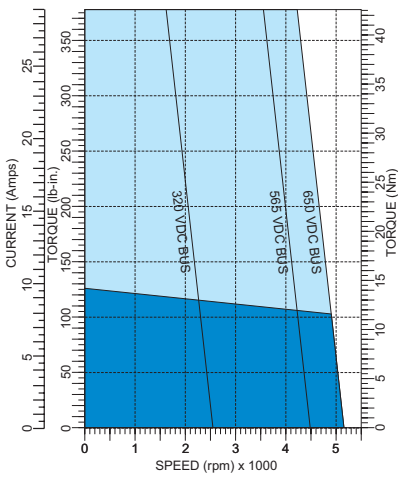

BSM100C-3250

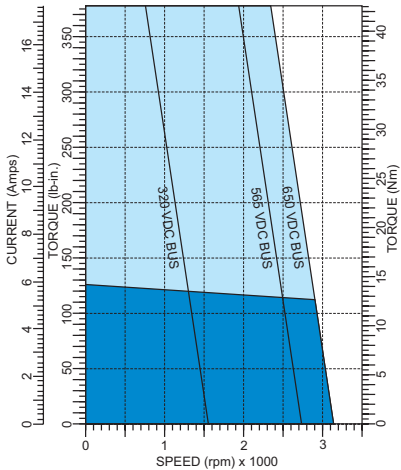

Model number		BSM100C-2250	BSM100C-3150	BSM100C-3250
General				
Continuous stall torque	lb-in	88.5	125.7	125.7
	Nm	10	14.2	14.2
Continuous current	amps	4.97	11.4	6.9
Peak torque	lb-in	265.5	377	377
	Nm	30	42.6	42.6
Peak current	amps	12.7	29	17.7
Thermal resistance	°C/watt	0.84	0.8	0.8
Thermal time constant	Min	54	62	62
Mechanical time constant	msec	2.56	2	1.94
Electrical time constant	msec	6	7.62	7.86
Rated speed @ 300 volts	rpm	1200	2400	1200
Rated speed @ 600 volts	rpm	2400	4800	2400
Electrical				
Torque constant	lb-in/amp	20.9	12.9	21.2
	Nm/amp	2.36	1.46	2.4
Voltage constant	Vpk/krpm	201.9	125	205.3
	Vrms/krpm	142.8	88.4	145.2
Resistance	ohms	4.2	0.84	2.2
Inductance	mH	25.2	6.4	17.3
Mechanical				
Inertia	lb-in-s ²	0.02991	0.04487	0.04487
	Kg-cm ²	33.77	50.66	50.66
Maximum speed	rpm	7,000	7,000	7,000
Number of motor poles	—	8	8	8
Weight	lbs/Kg	39/17.7	50/22.7	50/22.7

AC servo motors

BSM C-series performance curves

BSM100C-4150

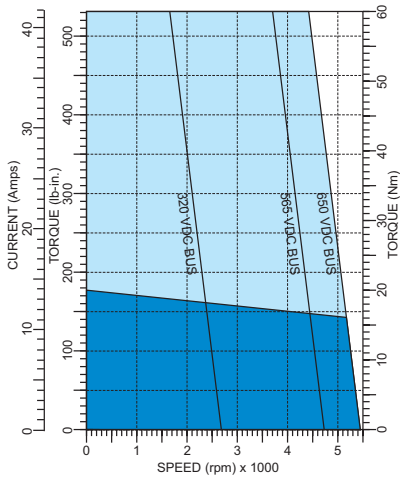

BSM100C-4250

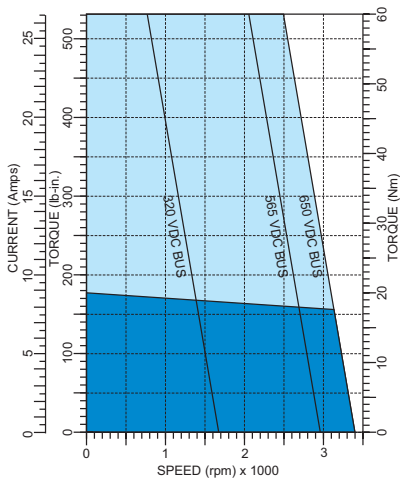

BSM100C-5150

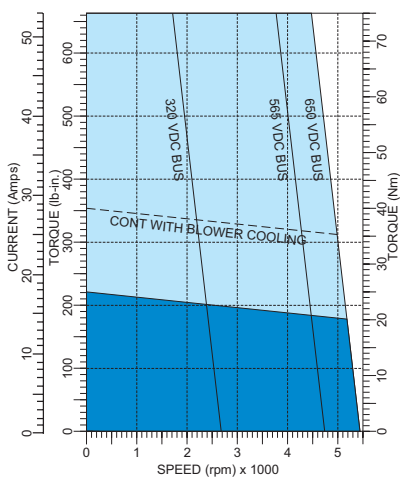

Model number		BSM100C-4150	BSM100C-4250	BSM100C-5150 ¹
General				
Continuous stall torque	lb-in	177	177	221.3
	Nm	20	20	25
Continuous current	amps	16.8	10.6	21
Peak torque	lb-in	531	531	663.8
	Nm	60	60	75
Peak current	amps	42.9	26.9	53.6
Thermal resistance	°C/watt	0.53	0.53	0.48
Thermal time constant	Min	70	70	77
Mechanical time constant	msec	2	2.06	1.8
Electrical time constant	msec	7.54	7.47	8.54
Rated speed @ 300 volts	rpm	2400	1200	2400
Rated speed @ 600 volts	rpm	4800	2400	4000
Electrical				
Torque constant	lb-in/amp	12.3	19.6	12.3
	Nm/amp	1.39	2.22	1.39
Voltage constant	Vpk/krpm	118.9	189.9	118.9
	Vrms/krpm	84.1	134.3	84.1
Resistance	ohms	0.57	1.5	0.41
Inductance	mH	4.3	11.2	3.5
Mechanical				
Inertia	lb-in-s ²	0.05982	0.05982	0.07478
	Kg-cm ²	67.54	67.54	84.43
Maximum speed	rpm	7,000	7,000	7,000
Number of motor poles	—	8	8	8
Weight	lbs/Kg	59/26.8	59/26.8	70/31.8

¹ A blower option is available which will increase the motor's continuous stall torque by another 60%.

AC servo motors

BSM C-series performance curves

2

BSM100C-5250

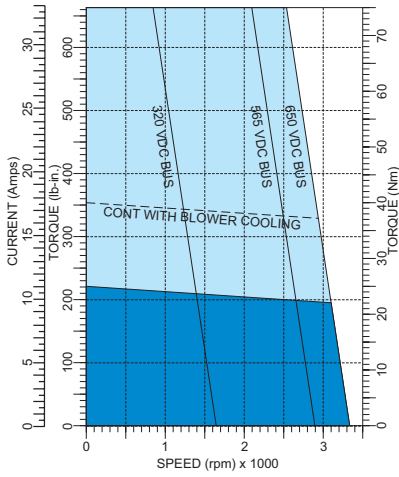

BSM100C-6150

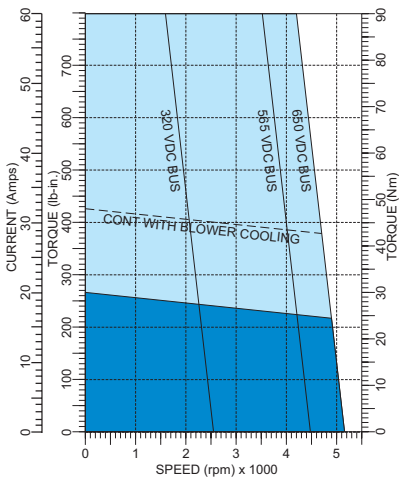

BSM100C-6250

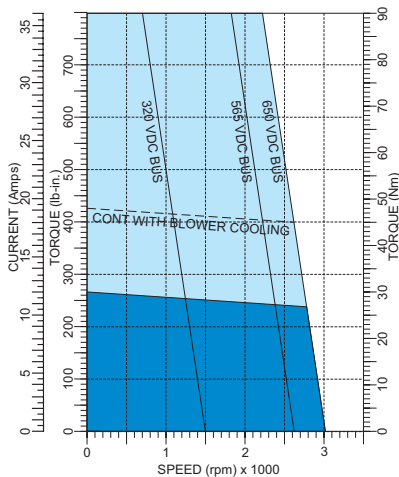

Model number		BSM100C-5250 ¹	BSM100C-6150 ¹	BSM100C-6250 ¹
General				
Continuous stall torque	lb-in	221.3	265.5	265.5
	Nm	25	30	30
Continuous current	amps	13	24	14.1
Peak torque	lb-in	663.8	796.5	796.5
	Nm	75	90	90
Peak current	amps	33.1	61.3	36
Thermal resistance	°C/watt	0.48	0.34	0.34
Thermal time constant	Min	77	85	85
Mechanical time constant	msec	1.77	2.15	1.96
Electrical time constant	msec	8.6	5.78	6
Rated speed @ 300 volts	rpm	1200	2000	1200
Rated speed @ 600 volts	rpm	2400	4000	2400
Electrical				
Torque constant	lb-in/amp	20	12.9	22.1
	Nm/amp	2.26	1.46	2.5
Voltage constant	Vpk/krpm	193.4	125	213.9
	Vrms/krpm	136.8	88.4	151.3
Resistance	ohms	1.07	0.37	1.2
Inductance	mH	9.2	2.6	7
Mechanical				
Inertia	lb-in-s ²	0.07478	0.0897	0.0897
	Kg-cm ²	84.43	101.27	101.27
Maximum speed	rpm	7,000	7,000	7,000
Number of motor poles	—	8	8	8
Weight	lbs/Kg	70/31.8	81/36.8	81/36.8

¹ A blower option is available which will increase the motor's continuous stall torque by another 60%.

AC servo motors

BSM C-series performance curves

BSM132C-3200AA

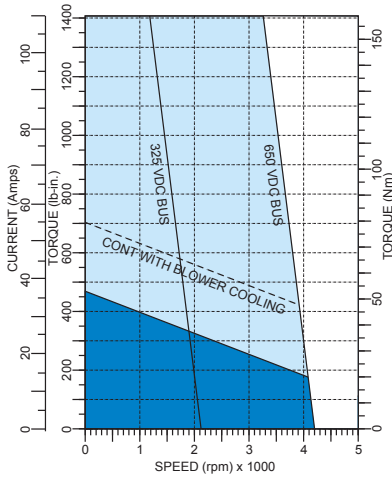

BSM132C-4200AA

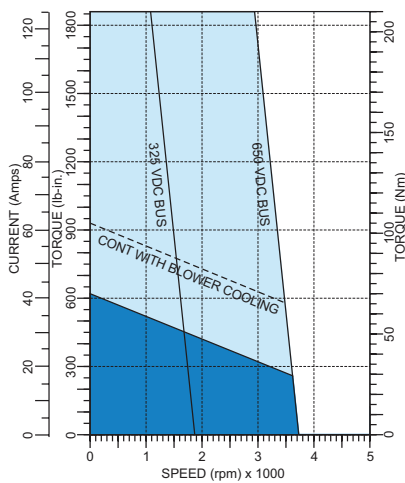

Model number		BSM132C-3200AA ¹	BSM132C-4200AA ¹
General			
Continuous stall torque	lb-in	469.1	619.5
	Nm	53	70
Continuous current	amps	37	43
Peak torque	lb-in	1407	1859
	Nm	159	210
Peak current	amps	110	129
Thermal resistance	°C/watt	0.25	0.22
Thermal time constant	Min	112	116
Mechanical time constant	msec	1.67	1.66
Electrical time constant	msec	15.31	17.38
Rated speed @ 600 volts	rpm	3500	3500
Rated speed @ 300 volts	rpm	1800	1800
Electrical			
Torque constant	lb-in/amp	16	18
	Nm/amp	1.8	2.03
Voltage constant	Vpk/krpm	154.6	174
	Vrms/krpm	109.4	123
Resistance	ohms	0.26	0.21
Inductance	mH	3.98	3.65
Mechanical			
Inertia	lb-in-s ²	0.185	0.287
	Kg-cm ²	208.865	324.023
Maximum speed	rpm	5,000	5,000
Number of motor poles	—	8	8
Weight	lbs/Kg	119/54.1	123/55.9

¹ A blower option is available which will increase the motor's continuous stall torque by another 45%.

AC servo motors

BSM C-series performance curves

2

BSM132C-5200AA

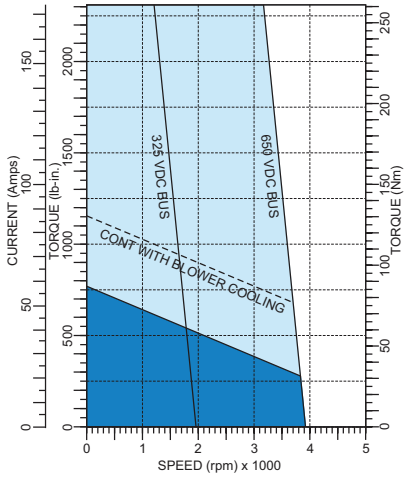

BSM132C-6200AA

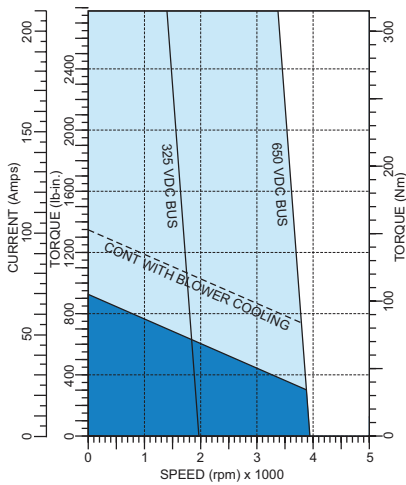

BSM132C-7200AA

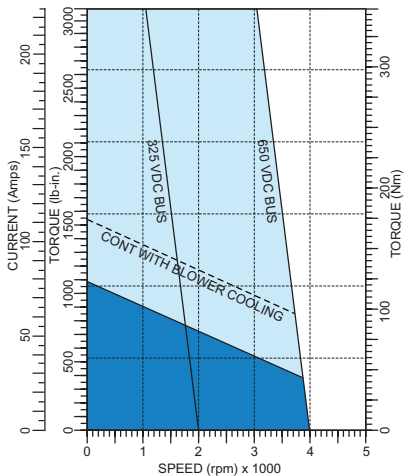

Model number		BSM132C-5200AA ¹	BSM132C-6200AA ¹	BSM132C-7200AA ¹
General				
Continuous stall torque	lb-in	770	929.3	1008.9
	Nm	87	105	114
Continuous current	amps	58	71	75
	Peak torque	lb-in	2310	2788
	Nm	261	315	342
Peak current	amps	174	212	225
Thermal resistance	°C/watt	0.17	0.17	0.17
Thermal time constant	Min	120	124	128
Mechanical time constant	msec	2.91	2.03	1.22
	Electrical time constant	msec	15.31	25.25
Rated speed @ 300 volts	rpm	1800	1800	1800
	Rated speed @ 600 volts	rpm	3500	3500
Electrical				
Torque constant	lb-in/amp	16.5	16.5	16.8
	Nm/amp	1.87	1.86	1.9
Voltage constant	Vpk/krpm	160.3	159.4	162.8
	Vrms/krpm	113.3	112.7	115.2
Resistance	ohms	0.26	0.16	0.087
Inductance	mH	3.98	3.99	2.65
Mechanical				
Inertia	lb-in-s ²	0.345	0.392	0.448
	Kg-cm ²	389.505	442.568	505.792
Maximum speed	rpm	5,000	5,000	5,000
Number of motor poles	—	8	8	8
Weight	lbs/Kg	148/67.3	172/78.2	191/86.8

¹ A blower option is available which will increase the motor's continuous stall torque by another 45%.

AC servo motors

BSM C-series performance curves

BSM132C-8200AA

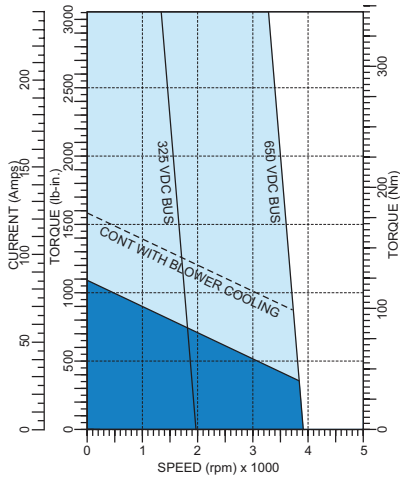

BSM132C-9200AA

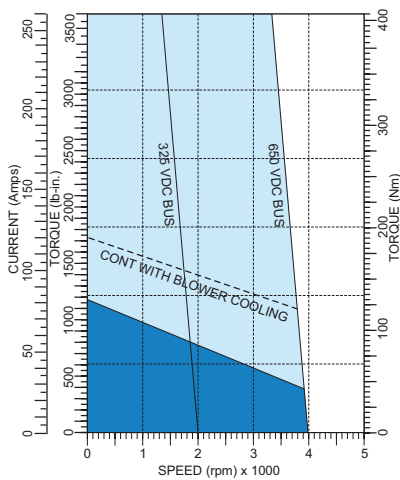

Model number		BSM132C-8200AA ¹	BSM132C-9200AA ¹
General			
Continuous stall torque	lb-in	1097.4	1185.9
	Nm	124	134
Continuous current	amps	80	88
Peak torque	lb-in	3292	3558
	Nm	372	402
Peak current	amps	240	264
Thermal resistance	°C/watt	0.17	0.17
Thermal time constant	Min	132	136
Mechanical time constant	msec	1.08	1.18
Electrical time constant	msec	32.86	26.21
Rated speed @ 300 volts	rpm	1800	1800
Rated speed @ 600 volts	rpm	3500	3500
Electrical			
Torque constant	lb-in/amp	17.2	16.8
	Nm/amp	1.94	1.9
Voltage constant	Vpk/krpm	166.3	162.8
	Vrms/krpm	117.6	115.2
Resistance	ohms	0.07	0.066
Inductance	mH	2.3	1.73
Mechanical			
Inertia	lb-in-s ²	0.513	0.57
	Kg-cm ²	579.177	643.53
Maximum speed	rpm	5,000	5,000
Number of motor poles	—	8	8
Weight	lbs/Kg	210/95.5	229/104.1

¹ A blower option is available which will increase the motor's continuous stall torque by another 45%.

AC servo motors

BSM series dimensions - IEC mountings

BSM50 series

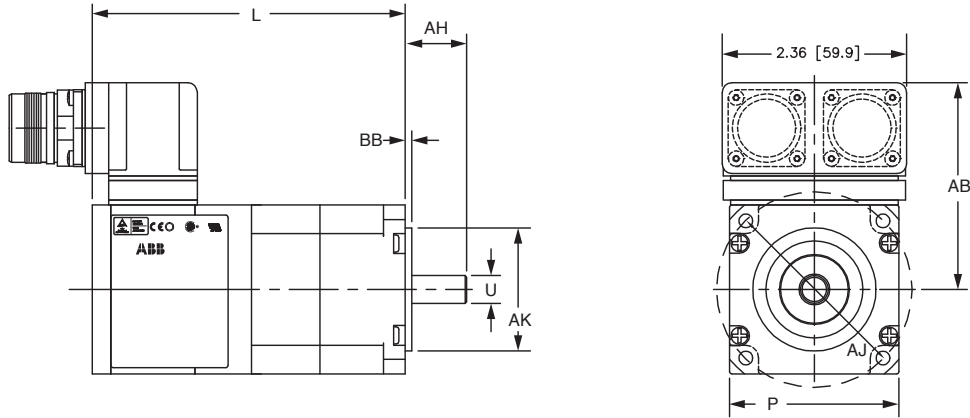

BSM63/80 series

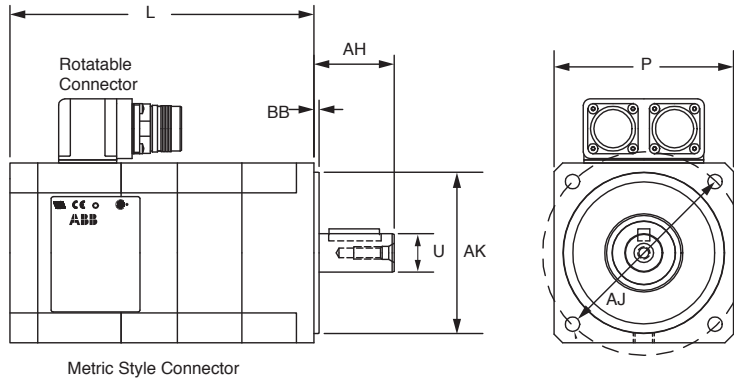

BSM90/100 series

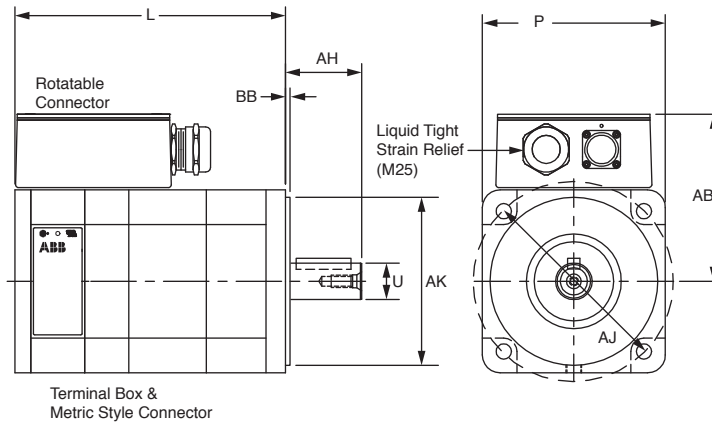

BSM132 series

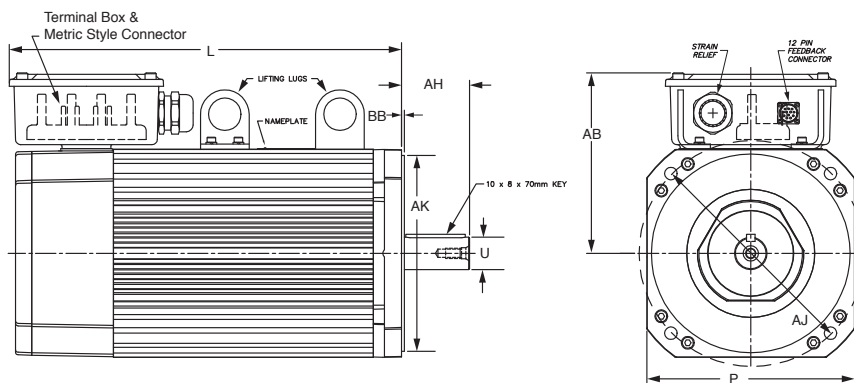

Note: M25 Strain Relief is used on all BSM90/100 Series rated for 20 amps. Motors rated for greater than 20 amps should use M40 strain relief (P/N MCS-M40) and M40/M25 adaptor (P/N MCS-M40A). Shipped with cable assembly. Rotatable connector not available on BSM50.

AC servo motors

BSM series dimensions - IEC mountings

Dimensions in mm (inch)

Motor code	P	AB	U	AH	Key	AJ	AK	BB
BSM50N	55 (2.17)	67 (2.64)	9j6 (0.35)	20 (0.78)	None	4.5 (0.18) thru hole 63 (2.5) B.C.	40j6 (1.5)	2.5 (0.098)
BSM63N	67 (2.6)	65 (2.6)	11j6 (0.43)	23 (0.9)	4x4x12	5.8 (0.23) thru hole 75 (3.0) B.C.	60j6 (2.3)	2.5 (0.098)
BSM80N/C	89 (3.5)	76 (3.0)	19j6 (0.74)	40 (1.5)	6x6x25	7.0 (0.28) thru hole 100 (3.9) B.C.	80j6 (3.1)	3.0 (0.118)
BSM90N/C	120 (4.7)	109 (4.3)	24j6 (0.94)	50 (2.0)	8x7x36	10 (0.39) thru hole 130 (5.1) B.C.	110j6 (4.3)	3.5 (0.138)
BSM100N/C	146 (5.7)	122 (4.8)	28j6 (1.1)	60 (2.3)	8x7x50	12 (0.47) thru hole 165 (6.5) B.C.	130j6 (5.1)	3.5 (0.138)
BSM132C	244 (9.6)	212 (8.35)	38 (1.49)	80 (3.1)	10x8x70	14.5 (0.57) thru hole 265 (10.4) B.C.	230 (9)	3.5 (0.138)

2

Length (without brake)					
Motor code	Resolver	Encoder	Motor code	Resolver	Encoder
BSM50N-1	101.7 (4.0)	128.7 (5.07)	BSM80C-1	144.0 (5.67)	144.0 (5.67)
BSM50N-2	127.1 (5.0)	154.1 (6.07)	BSM80C-2	169.4 (6.67)	169.4 (6.67)
BSM50N-3	152.5 (6.0)	179.5 (7.07)	BSM80C-3	194.8 (7.67)	194.8 (7.67)
BSM63N-1	115.8 (4.56)	125.9 (4.96)	BSM80C-4	220.2 (8.67)	220.2 (8.67)
BSM63N-2	141.2 (5.56)	151.3 (5.96)	BSM90C-1	164.7 (6.49)	164.7 (6.49)
BSM63N-3	166.6 (6.56)	176.7 (6.96)	BSM90C-2	202.8 (7.99)	202.8 (7.99)
BSM80N-1	150.7 (5.93)	150.7 (5.93)	BSM90C-3	240.9 (9.49)	240.9 (9.49)
BSM80N-2	182.5 (7.18)	182.5 (7.18)	BSM90C-4	279.1 (10.99)	279.1 (10.99)
BSM80N-3	214.2 (8.43)	214.2 (8.43)	BSM100C-1	164.7 (6.49)	164.7 (6.49)
BSM90N-1	177.4 (6.99)	177.4 (6.99)	BSM100C-2	202.8 (7.99)	202.8 (7.99)
BSM90N-2	228.2 (8.99)	228.2 (8.99)	BSM100C-3	240.9 (9.49)	240.9 (9.49)
BSM90N-3	279.0 (10.99)	279.0 (10.99)	BSM100C-4	279.0 (10.99)	279.0 (10.99)
BSM100N-1	203.1 (8.02)	203.1 (8.02)	BSM100C-5	317.1 (12.49)	317.1 (12.49)
BSM100N-2	253.9 (10.0)	253.9 (10.0)	BSM100C-6	355.2 (13.99)	355.2 (13.99)
BSM100N-3	304.7 (12.0)	304.7 (12.0)	BSM132C-3	384 (15.12)	384 (15.12)
BSM100N-4	355.5 (14.0)	355.5 (14.0)	BSM132C-4	409.4 (16.12)	409.4 (16.12)
			BSM132C-5	434.8 (17.12)	434.8 (17.12)
			BSM132C-6	460.2 (18.12)	460.2 (18.12)
			BSM132C-7	485.6 (19.12)	485.6 (19.12)
			BSM132C-8	511 (20.12)	511 (20.12)
			BSM132C-9	536.4 (21.12)	536.4 (21.12)

Motor code	Brake motor length - adder		Brake motor weight - adder
	Resolver	Encoder	
BSM50N	36.1 (1.42)	36.1 (1.42)	0.84 lbs
BSM63N	29.0 (1.14)	43.18 (1.70)	1.02 lbs
BSM80N/C	27.2 (1.07)	41.66 (1.64)	2.18 lbs
BSM90N/C	60.71 (2.39)	60.71 (2.39)	5.74 lbs
BSM100N/C	40.64 (1.60)	67.06 (2.64)	8.77 lbs
BSM132C	96.01 (3.78)	96.01 (3.78)	35.6 lbs

Note: Standard configuration: All motors supplied with feedback device. Square mounting flange. The motors have a threaded hole on the shaft end. The BSM63 series is M4 x 0.7 threads (11mm deep). The BSM80 series is M6 x 1.0 threads (17 mm deep). The BSM90 series is M6 x 1.0 threads (17 mm deep). The BSM100 series is M10 x 1.5 threads (23 mm deep).

The BSM132 series is M12x1.5 threads (27 mm deep). Dimensions are for reference only and may change for other selected option. Detailed engineering drawings are available upon request. Contact ABB for dimensions with other feedback devices.

AC servo motors

BSM series dimensions - NEMA mountings

2

BSM50 series NEMA 23

Optional NEMA 23 mounting

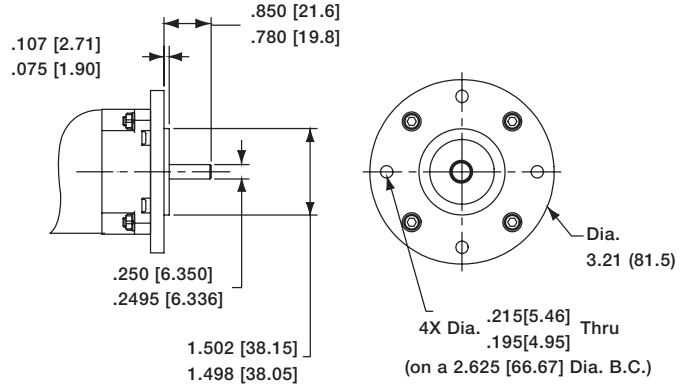
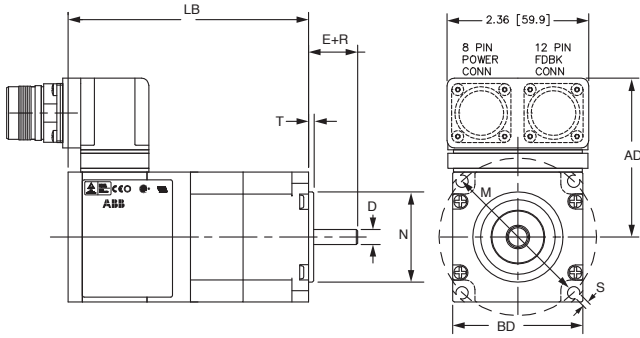

BSM63/80 series NEMA 34/42

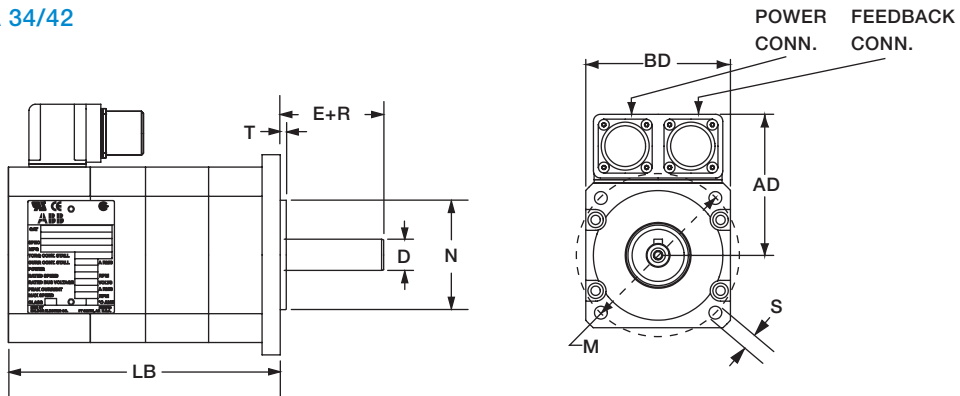

BSM90/100 series NEMA 56

NEMA key configuration

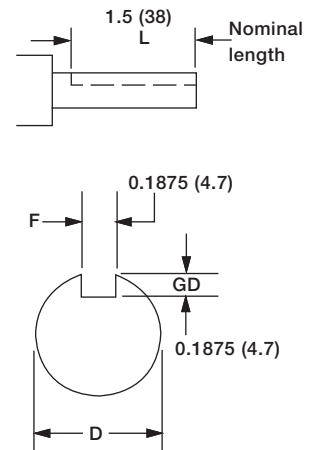
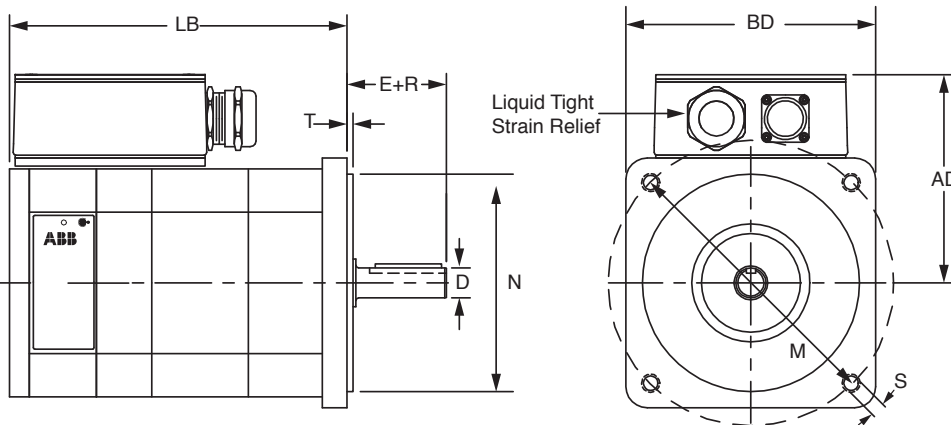

Note: Dimensions shown for BSM5NN, BSM6NN, BSM8NN, BSM8NC, BSM9NN, BSM9NC, 10NN, and 10NC (NEMA 23, 34,42, & 56). BSM5NN has no keyway as standard.

AC servo motors

BSM Series dimensions - NEMA mountings

Dimensions in inch (mm)

NEMA code	Motor code	BD	AD	D	E + R	M	S thru	N	T
23	BSM5NN	2.2 (55)	2.64 (67)	0.25 (6.3)	0.812 (20)	2.625 (66.7)	0.2 (5.1) Hole	1.5 (38)	0.10 (2.5)
34	BSM6NN	3.14 (80)	2.88 (73)	0.375 (9.5)	0.9 (22)	3.875 (98.4)	0.22 (5.6) Hole	2.875 (73)	0.10 (2.5)
42	BSM8NN	4.0 (101)	3.0 (76)	0.625 (15)	2.0 (52)	4.95 (125.7)	0.28 (7.1) Hole	2.187 (55)	0.10 (2.5)
42	BSM8NC	4.0 (101)	3.0 (76)	0.625 (15)	2.0 (52)	4.95 (125.7)	0.28 (7.1) Hole	2.187 (55)	0.10 (2.5)
56	BSM9NN	5.17 (131)	4.3 (108)	0.625 (15)	2.0 (52)	5.875 (149.2)	0.375-16 THD	4.5 (114)	0.10 (2.5)
56	BSM9NC	5.17 (131)	4.3 (108)	0.625 (15)	2.0 (52)	5.875 (149.2)	0.375-16 THD	4.5 (114)	0.13 (3.3)
56	BSM10NN	5.75 (146)	4.8 (122)	0.625 (15)	2.0 (52)	5.875 (149.2)	0.375-16 THD	4.5 (114)	0.13 (3.3)
56	BSM10NC	5.75 (146)	4.8 (122)	0.625 (15)	2.0 (52)	5.875 (149.2)	0.375-16 THD	4.5 (114)	0.13 (3.3)

NEMA code	Length - LB			Length - LB		
	Motor code	Resolver	Encoder	Motor Code	Resolver	Encoder
23	BSM5NN-1	4.0 (101.7)	5.07 (128.7)	—	—	—
	BSM5NN-2	5.0 (127.1)	6.07 (154.1)	—	—	—
	BSM5NN-3	6.0 (152.5)	7.07 (179.5)	—	—	—
34	BSM6NN-1	4.56 (115.8)	5.33 (135.5)	—	—	—
	BSM6NN-2	5.56 (141.2)	5.96 (151.3)	—	—	—
	BSM6NN-3	6.56 (166.6)	6.96 (176.7)	—	—	—
42	BSM8NN-1	5.96 (151.3)	5.96 (151.3)	BSM8NC-1	5.67 (144.0)	5.69 (144.6)
	BSM8NN-2	7.21(183.0)	7.21 (183.0)	BSM8NC-2	6.67 (169.0)	6.69 (170.0)
	BSM8NN-3	8.46 (214.8)	8.46 (214.8)	BSM8NC-3	7.67 (194.8)	7.69 (195.4)
	-	-	-	BSM8NC-4	8.67 (220.2)	8.69 (220.8)
56	BSM9NN-1	6.99 (177.4)	6.99 (177.4)	BSM9NC-1	6.49 (164.7)	6.49 (164.7)
	BSM9NN-2	8.99 (228.2)	8.99 (228.2)	BSM9NC-2	7.99 (202.8)	7.99 (202.8)
	BSM9NN-3	10.99 (279.0)	10.99 (279.0)	BSM9NC-3	9.49 (240.9)	9.49 (240.9)
	BSM10NN-1	8.02 (203)	8.02 (203)	BSM10NC-1	6.49 (164.7)	6.49 (164.7)
	BSM10NN-2	10.0 (253.9)	10.0 (253.9)	BSM10NC-2	7.99 (202.8)	7.99 (202.8)
	BSM10NN-3	12.0 (304.7)	12.0 (304.7)	BSM10NC-3	9.49 (240.9)	9.49 (240.9)
	BSM10NN-4	14.0 (355.5)	14.0 (355.5)	BSM10NC-4	10.99 (279.0)	10.99 (279.0)
	-	-	-	BSM10NC-5	12.49 (317.1)	12.49 (317.1)
-	-	-	BSM10NC-6	13.99 (355.2)	13.99 (355.2)	

Note: Standard configuration: All motors are supplied with feedback device, NEMA mounting.
 BSM 50/63/80 has two (2) threaded connectors for resolver and motor terminations.
 BSM90/100 has one (1) threaded connector for resolver, termination of motor lead wires on terminal block.
 Order mating cable assemblies/connectors as separate items.
 Dimensions are for reference only. Detailed engineering drawings are available upon request.
 Contact ABB for dimension with other feedback devices and configurations.
 Motor identification/optional specifying information MUST include the code of "N" designating NEMA dimensions, i.e. "BSM8NN-XXX".
 Contact ABB for other shaft dimensions.

AC servo motors

BSM90/100 series

2

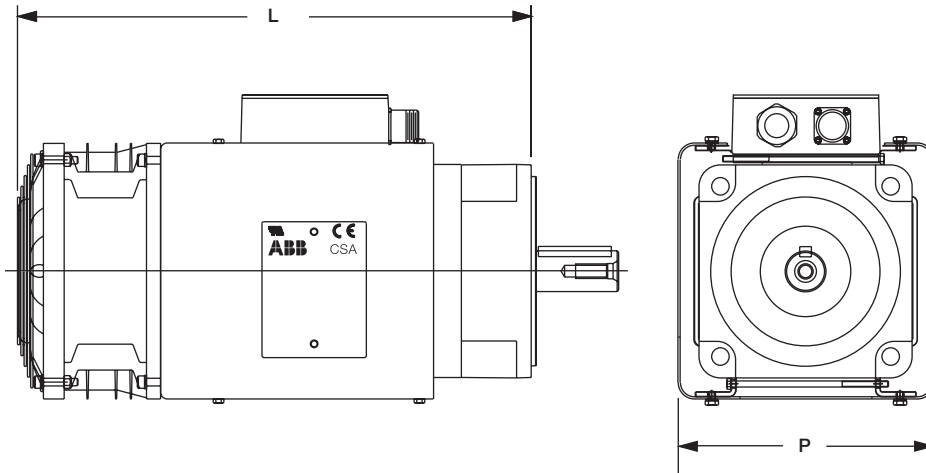

BSM132 series

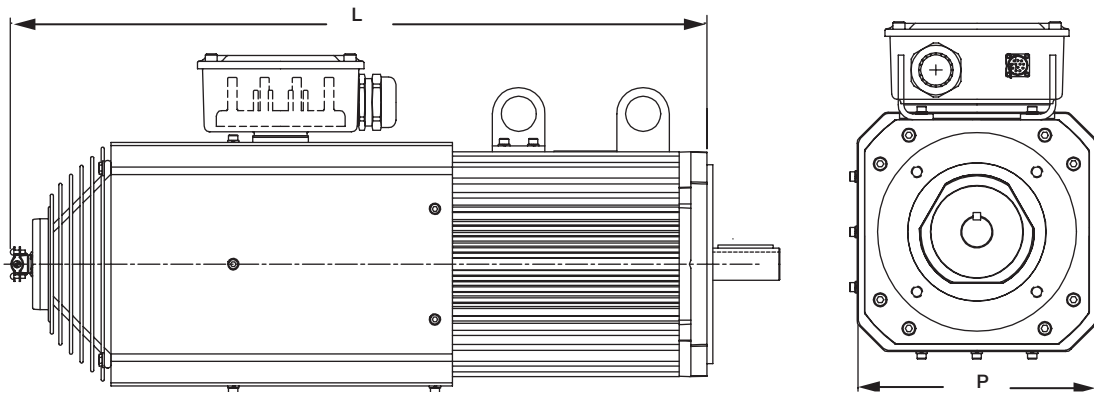

Blower Volt/Amp

Motor	Voltage	Amps	CFM
BSM90/100	115 VAC 1 ϕ 50/60 Hz	0.60	430
	230 VAC 1 ϕ 50/60 Hz	0.30	430
	24 Vdc	2.10	470
BSM132	230 VAC 3 ϕ 60 Hz	0.80	
	460 VAC 3 ϕ 60 Hz	0.40	

Note: Dimensions are for reference only.

Detailed engineering drawings available upon request. Order blower separately

BSM132 blower can not be installed on motor in the field. It must be specified when motor order is placed.

AC servo motors

BSM series - blower cooling option

Blower Kits for use with BSM90/100 motors

Motor code		Blower kit number			P dimension		L dimension	
		115 VAC 1Ø	230 VAC 1Ø	24 Vdc	mm	inch	mm	inch
BSM90N-2	Motor	BSM90N-2FN-1	BSM90N-2FN-8	BSM90N-2FN-D	175.5	6.91	381.8	15.03
	Motor-brake	BSM90N-2FNB-1	BSM90N-2FNB-8	BSM90N-2FNB-D	175.5	6.91	442.5	17.42
BSM90N-3	Motor	BSM90N-3FN-1	BSM90N-3FN-8	BSM90N-3FN-D	175.5	6.91	432.6	17.03
	Motor-brake	BSM90N-3FNB-1	BSM90N-3FNB-8	BSM90N-3FNB-D	175.5	6.91	493.3	19.42
BSM100N-3	Motor	BSM100N-3FN-1	BSM100N-3FN-8	BSM100N-3FN-D	175.5	6.91	453.5	17.85
	Motor-brake	BSM100N-3FNB-1	BSM100N-3FNB-8	BSM100N-3FNB-D	175.5	6.91	475.3	18.71
BSM100N-4	Motor	BSM100N-4FN-1	BSM100N-4FN-8	BSM100N-4FN-D	175.5	6.91	504.3	19.85
	Motor-brake	BSM100N-4FNB-1	BSM100N-4FNB-8	BSM100N-4FNB-D	175.5	6.91	526.1	20.71
BSM90C-2	Motor	BSM90C-2FN-1	BSM90C-2FN-8	BSM90C-2FN-D	175.5	6.91	356.4	14.03
	Motor-brake	BSM90C-2FNB-1	BSM90C-2FNB-8	BSM90C-2FNB-D	175.5	6.91	417.1	16.42
BSM90C-3	Motor	BSM90C-3FN-1	BSM90C-3FN-8	BSM90C-3FN-D	175.5	6.91	394.5	15.53
	Motor-brake	BSM90C-3FNB-1	BSM90C-3FNB-8	BSM90C-3FNB-D	175.5	6.91	455.2	17.92
BSM100C-3	Motor	BSM100C-3FN-1	BSM100C-3FN-8	BSM100C-3FN-D	175.5	6.91	391.1	15.4
	Motor-brake	BSM100C-3FNB-1	BSM100C-3FNB-8	BSM100C-3FNB-D	175.5	6.91	437.8	17.24
BSM100C-4	Motor	BSM100C-4FN-1	BSM100C-4FN-8	BSM100C-4FN-D	175.5	6.91	429.2	16.9
	Motor-brake	BSM100C-4FNB-1	BSM100C-4FNB-8	BSM100C-4FNB-D	175.5	6.91	475.9	18.74
BSM100C-5	Motor	BSM100C-5FN-1	BSM100C-5FN-8	BSM100C-5FN-D	175.5	6.91	467.3	18.4
	Motor-brake	BSM100C-5FNB-1	BSM100C-5FNB-8	BSM100C-5FNB-D	175.5	6.91	514	20.24
BSM100C-6	Motor	BSM100C-6FN-1	BSM100C-6FN-8	BSM100C-6FN-D	175.5	6.91	505.4	19.9
	Motor-brake	BSM100C-6FNB-1	BSM100C-6FNB-8	BSM100C-6FNB-D	175.5	6.91	590.2	23.24

Blower Kits for use with BSM132C motors

Motor code		Kit must be ordered with motor	P dimension		L dimension	
			230/460 VAC 3Ø	mm	inch	mm
BSM132C-3	Motor	Factory fit option only.	260.1	10.24	587.0	23.11
	Motor-brake		260.1	10.24	683.0	26.89
BSM132C-4	Motor		260.1	10.24	612.4	24.11
	Motor-brake		260.1	10.24	708.4	27.89
BSM132C-5	Motor		260.1	10.24	637.8	25.11
	Motor-brake		260.1	10.24	733.8	28.89
BSM132C-6	Motor		260.1	10.24	663.2	26.11
	Motor-brake		260.1	10.24	759.2	29.89
BSM132C-7	Motor		260.1	10.24	688.6	27.11
	Motor-brake		260.1	10.24	784.6	30.89
BSM132C-8	Motor		260.1	10.24	714.0	28.11
	Motor-brake		260.1	10.24	810.0	31.89
BSM132C-9	Motor		260.1	10.24	739.4	29.11
	Motor-brake		260.1	10.24	835.4	32.89

AC servo motors

Stainless steel brushless servo

Our totally stainless steel SSBSM series of motors are designed for food, liquid, washdown, hygiene and harsh, corrosive environments. These motors are designed to handle IP67 and withstand 1500 psi (103 bar) washdown conditions. Offered in standard and low inertia designs for best machine inertial matching. Included in this quality design are Teflon stainless steel double-sealed bearings with Viton O-rings, environmental protected stator with premium moisture resistant wire, and internal thermal over temperature protection. The SSBSM products are designed to be durable - they are BISSC, UL, cUL and CE approved.



3

Torque range low inertia models

- SSBSM50N 3.9-12 lb-in (0.45-1.3 Nm)
- SSBSM63N 13-18.5 lb-in (1.4-2 Nm)
- SSBSM80N 23-32 lb-in (2.5-3.6 Nm)

Torque range standard inertia models

- SSBSM80C 8-30 lb-in (0.9-3.4 Nm)

Construction - All stainless steel provides protection in harsh environments and washdown conditions - 304 housing, 416 shaft

Stator - Reliable potted design provides environmental protection, high current spike protection and high voltage protection.

Wire - Premium 200°C moisture resistant, multi-coated copper wire - to improve your reliability

Insulation - UL rated for 130°C rise, and potted - to provide you with extra high insulation/safety

Grease - Exxon Polyrex EX Polyurea - proven to provide 4 times greater life - H1 bearing grease for incidental food contact.

FDA approved shaft seal

Bearings - Quality grade ball bearings - to provide you with dependability and long trouble free life.

Magnets - High energy - provides very high resistance to demagnetization, so the motor always performs.

Armature - proven quality design - to supply superior performance for your application.

Motor housing - Durable design to handle IP67 and harsh 1500 psi (103 bar) washdown conditions.

Feedback - Variety available: resolver, encoder, absolute encoder - choices for your application.

Laser etched nameplate
- easy to clean
- protects against contamination

Internal Thermal protection - to supply you with safeguards against overheating and overload conditions.

BISSC/UL/CSA/CE - Agency approvals - proven design, proven quality, proven reliability.

Stock and custom designs available. Optional holding brakes available. Typical BSM63/80 series shown.

AC servo motors

SSBSM-series

Our totally stainless steel SSBSM series of motors are designed for food, liquid, hygiene or corrosive environments. These motors are designed to handle IP67 applications and withstand 1500 psi washdown conditions. Included in this quality design are double sealed bearings and O-rings, environmentally protected stator design with premium moisture resistant wire, and internal thermal over temperature protection. The SSBSM products are designed to be durable - they are BISSC, UL, cUL and CE approved.

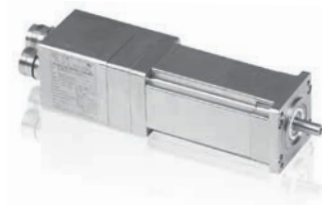

3

Stainless steel brushless servo motors

Continuous stall torque		Continuous stall amps	Speed RPM @ 320V	Motor catalog number	Motor inertia	
lb-in	Nm				lb-in-s ²	Kg-cm ²
Standard inertia stainless steel brushless servo motors - SSBSM C-series						
8	0.9	1.5	4000	SSBSM80C-175CX	0.0016	1.81
17	1.9	2.6	4000	SSBSM80C-275CX	0.0033	3.73
25	2.8	5	4000	SSBSM80C-375CX	0.0049	5.54
30	3.4	5.3	4000	SSBSM80C-475CX	0.0066	7.45
Low inertia stainless steel brushless servo motors - SSBSM N-series						
3.9	0.45	0.8	4000	SSBSM50N-175CX	0.00006	0.0677
7.9	0.9	1.4	4000	SSBSM50N-275CX	0.00011	0.124
12	1.3	2.4	4000	SSBSM50N-375CX	0.00016	0.18
13	1.4	1.9	4000	SSBSM63N-275CX	0.00034	0.384
18.5	2.0	2.8	4000	SSBSM63N-375CX	0.00050	0.564
23	2.5	3.1	4000	SSBSM80N-275CX	0.00162	1.82
32	3.6	4.28	4000	SSBSM80N-375CX	0.00223	2.51

Note: ¹ Nominal rpm shown at 320 Vdc bus for convenience. For 640 Vdc double the speed. Reference motor table to verify that max speed is not exceeded.

² Stainless steel connectors rated for 20 amps. ³ For X callout, see motor ID matrix.

AC servo motors

SSBSM stainless series performance curves

SSBSM80C-175

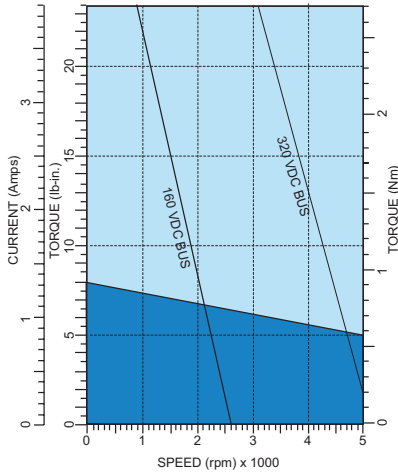

SSBSM80C-275

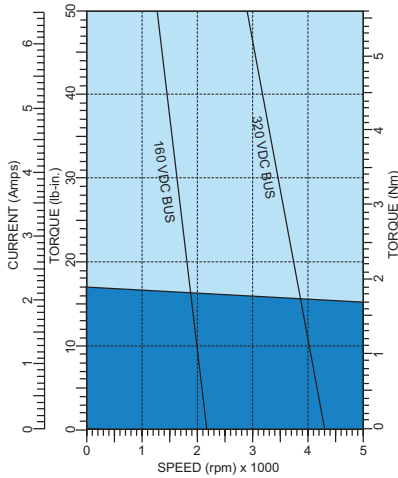

SSBSM80C-375

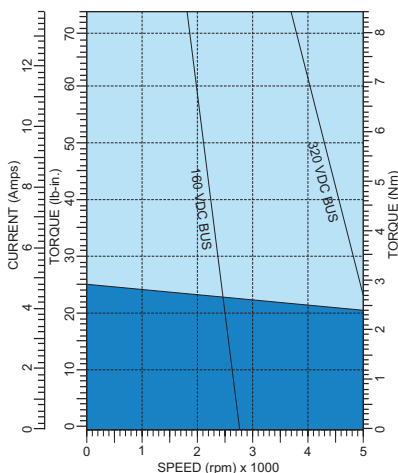

Model number		SSBSM80C-175	SSBSM80C-275	SSBSM80C-375
General				
Continuous stall torque	lb-in	8	16.8	24.8
	Nm	0.9	1.9	2.8
Continuous current	amps	1.5	2.6	5
	Peak torque	lb-in	23.9	50.4
	Nm	2.7	5.7	8.4
Peak current	amps	3.9	6.6	13.9
Thermal resistance	°C/watt	2.08	1.78	1.58
Thermal time constant	Min	19	23	28
Mechanical time constant	msec	5.96	3.54	2.7
Electrical time constant	msec	1.65	2.63	3.73
Rated speed @ 300 volts	rpm	4000	4000	4000
Rated speed @ 160 volts	rpm	2130	2130	2130
Electrical				
Torque constant	lb-in/amp	6.5	7.7	6
	Nm/amp	0.73	0.87	0.67
Voltage constant	Vpk/krpm	62.5	74.5	57.5
	Vrms/krpm	44.2	52.7	40.7
Resistance	ohms	17.6	7.2	2.2
Inductance	mH	29.1	18.9	8.2
Mechanical				
Inertia	lb-in-s ²	0.0016	0.0033	0.0049
	Kg-cm ²	1.81	3.73	5.53
Maximum speed (1)	rpm	10,000	10,000	10,000
Number of motor poles	—	4	4	4
Weight	lbs/Kg	12/5.5	15/6.8	18/8.2

(1) Maximum speed can be limited by bus volts and feedback types.

AC servo motors

SSBSM stainless series performance curves

SSBSM80C-475

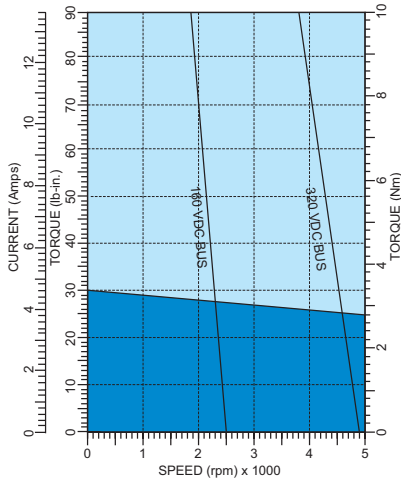

SSBSM50N-175

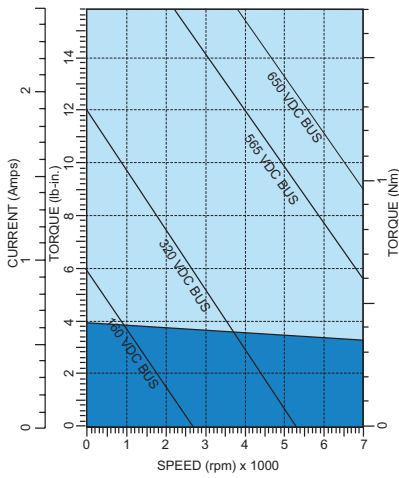

Model number		SSBSM80C-475	SSBSM50N-175
General			
Continuous stall torque	lb-in	30.1	3.9
	Nm	3.4	0.45
Continuous current	amps	5.3	0.79
Peak torque	lb-in	90.3	15.9
	Nm	10.2	1.8
Peak current	amps	13.6	2.5
Thermal resistance	°C/watt	1.82	2.85
Thermal time constant	Min	32	7
Mechanical time constant	msec	2.42	0.6
Electrical time constant	msec	3.16	1.3
Rated speed @ 300 volts	rpm	4000	4000
Rated speed @ 160 volts	rpm	2130	2130
Electrical			
Torque constant	lb-in/amp	6.7	6.31
	Nm/amp	0.76	0.71
Voltage constant	Vpk/krpm	65.2	60.94
	Vrms/krpm	46	43.1
Resistance	ohms	1.9	47.5
Inductance	mH	6.2	63.5
Mechanical			
Inertia	lb-in-s ²	0.0066	0.00006
	Kg-cm ²	7.45	0.0677
Maximum speed (1)	rpm	10,000	10,000
Number of motor poles	—	4	4
Weight	lbs/Kg	21/9.5	5/2.3

(1) Maximum speed can be limited by bus volts and feedback types.

AC servo motors

SSBSM stainless series performance curves

SSBSM50N-275

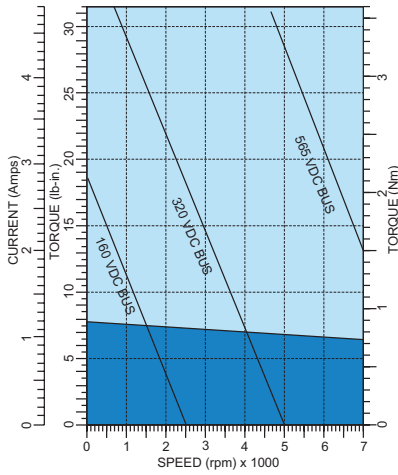

SSBSM50N-375

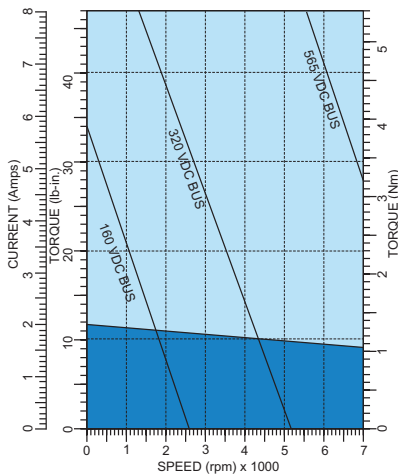

SSBSM63N-275

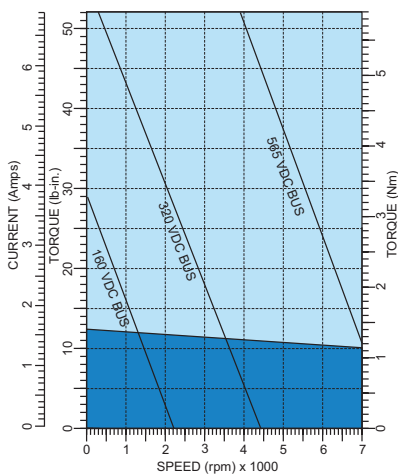

Model number		SSBSM50N-275	SSBSM50N-375	SSBSM63N-275
General				
Continuous stall torque	lb-in	7.9	12	13
	Nm	0.9	1.3	1.4
Continuous current	amps	1.4	2.4	1.9
Peak torque	lb-in	32	48	52
	Nm	3.6	5.4	5.9
Peak current	amps	4.8	8	6.9
Thermal resistance	°C/watt	2.76	1.77	2.08
Thermal time constant	Min	11	19	19
Mechanical time constant	msec	0.35	0.29	0.62
Electrical time constant	msec	2.1	1.8	2.1
Rated speed @ 300 volts	rpm	4000	4000	4000
Rated speed @ 160 volts	rpm	2130	2130	2130
Electrical				
Torque constant	lb-in/amp	6.6	6.4	7.47
	Nm/amp	0.75	0.72	0.84
Voltage constant	Vpk/krpm	64.34	61.9	72.1
	Vrms/krpm	45.5	43.8	51
	ohms	16	8.5	11.6
Inductance	mH	33.2	16	24.7
Mechanical				
Inertia	lb-in-s ²	0.00011	0.00016	0.00034
	Kg-cm ²	0.124	0.18	0.384
Maximum speed (1)	rpm	10,000	10,000	10,000
Number of motor poles		4	4	4
Weight	lbs/Kg	5.75/2.6	6.5/2.9	8/3.6

(1) Maximum speed can be limited by bus volts and feedback types.

AC servo motors

SSBSM stainless series performance curves

SSBSM63N-375

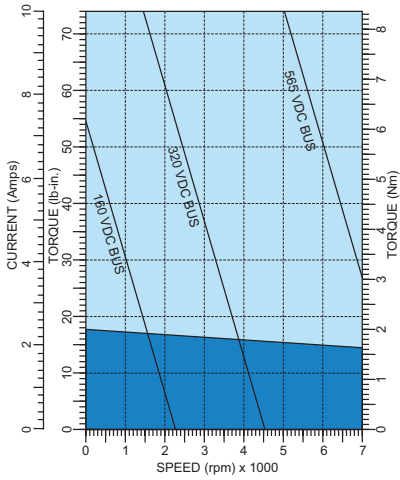

SSBSM80N-275

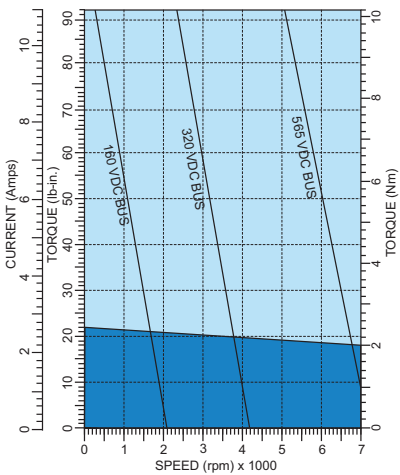

SSBSM80N-375

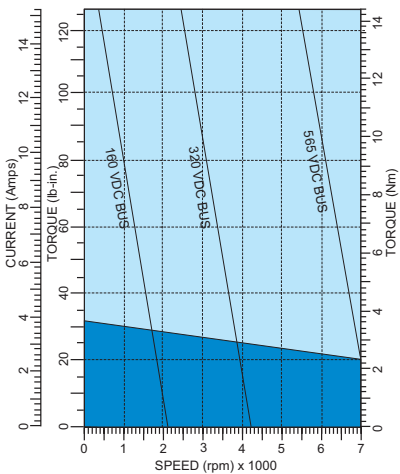

Model number		SSBSM63N-375	SSBSM80N-275	SSBSM80N-375
General				
Continuous stall torque	lb-in	18.5	23	32
	Nm	2	2.5	3.6
Continuous current	amps	2.8	3.1	4.3
	Peak torque	lb-in	74	92
	Nm	8.4	10.4	14.5
Peak current	amps	10	11.2	15.4
Thermal resistance	°C/watt	1.87	2.82	2.02
Thermal time constant	Min	23	28	34
Mechanical time constant	msec	0.5	0.72	0.69
Electrical time constant	msec	2.3	3.9	4.2
Rated speed @ 300 volts	rpm	4000	4000	4000
Rated speed @ 160 volts	rpm	2130	2130	2130
Electrical				
Torque constant	lb-in/amp	7.2	8	8
	Nm/amp	0.82	0.9	0.9
Voltage constant	Vpk/krpm	70.2	77.3	77.4
	Vrms/krpm	49.7	54.7	54.7
Resistance	ohms	5.92	3.2	2.22
Inductance	mH	13.65	12.73	9.3
Mechanical				
Inertia	lb-in-s ²	0.0005	0.00162	0.00223
	Kg-cm ²	0.564	1.82	2.51
Maximum speed (1)	rpm	10,000	7,000	7,000
Number of motor poles	—	4	4	4
Weight	lbs/Kg	9/4.0	15.5/7	18.5/8.4

(1) Maximum speed can be limited by bus volts and feedback types.

AC servo motors

Stainless steel brushless servo motors

SSBSM series dimensions - IEC mountings

SSBSM50/63/80 series

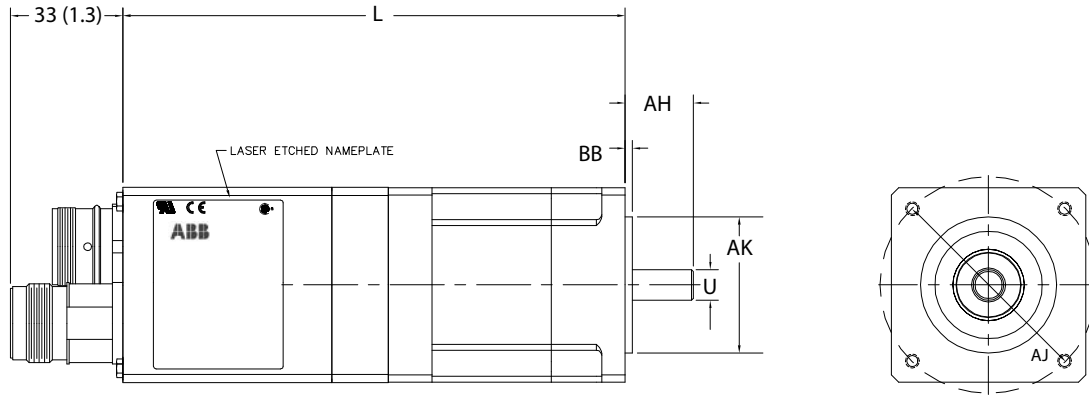

Dimensions in mm (inch)

Motor code	P	U	AH	Key	AJ	AK	BB
SSBSM50N	57 (2.25)	9 (0.35)	20 (0.78)	NONE	4.5 (0.18) thru hole 63 (2.5) B.C.	40 (1.5)	2.5 (0.098)
SSBSM63N	69 (2.72)	11 (0.43)	23 (0.9)	4x4x12	5.8 (0.23) thru hole 75 (3.0) B.C.	60 (2.3)	2.5 (0.098)
SSBSM80C/N	91.3 (3.59)	19 (0.74)	40 (1.5)	6x6x25	7.0 (0.28) thru hole 100 (3.9) B.C.	80 (3.1)	3.0 (0.118)

Motor code	Length - L		Motor code	Length - L	
	Resolver	Encoder		Resolver	Encoder
SSBSM50N-1	147.4 (5.80)	147.4 (5.80)	SSBSM80C-1	156.2 (6.15)	156.2 (6.15)
SSBSM50N-2	172.8 (6.80)	172.8 (6.80)	SSBSM80C-2	181.6 (7.15)	181.6 (7.15)
SSBSM50N-3	198.2 (7.80)	198.2 (7.80)	SSBSM80C-3	207.0 (8.15)	207.0 (8.15)
SSBSM63N-2	180.9 (7.12)	180.9 (7.12)	SSBSM80C-4	232.4 (9.15)	232.4 (9.15)
SSBSM63N-3	206.3 (8.12)	206.3 (8.12)			
SSBSM80N-2	194.3 (7.65)	194.3 (7.65)			
SSBSM80N-3	226.1 (8.90)	226.1 (8.90)			

Motor code	Brake motor length - adder		Brake motor weight - adder
	Resolver	Encoder	
SSBSM50N	37.3 (1.47)	37.3 (1.47)	0.84 lbs
SSBSM63N	46.2 (1.82)	46.2 (1.82)	1.02 lbs
SSBSM80N/C	44.7 (1.76)	44.7 (1.76)	2.18 lbs

Note: Standard configuration: All motors supplied with feedback device. Square mounting flange.
 SSBSM 50/63/80 has two (2) threaded connectors for feedback and motor terminations.
 Order mating cable assemblies/connectors as separate items.
 The motors have a threaded hole on the shaft end. The SSBSM63 series is M4 x 0.7 threads (11mm deep). The SSBSM80 series is M6 x 1.0 threads (17 mm deep).
 Contact ABB for dimensions with other feedback devices.

AC servo motors

Brushless motors BSM 25 & 33 series

The BSM 25 and 33 series provide a durable round housing design that has the capability of a foot mounting. Using our standard reliable Neodymium magnet design, many applications, especially adjustable speed applications, can now make use of brushless technology benefits – less maintenance, quieter operation, faster acceleration, higher torque and power output. Although introduced with Hall sensor feedback for adjustable speed applications, the BSM25 and BSM33 series are available with a wide variety of feedback devices to suit demanding servo application needs.



Torque range

- BSM25 1/4 - 1/2 HP – 18-23 lb-in (2-2.6 Nm)
- BSM33 1/2 - 3 HP – 27 - 138 lb-in (3-15.6 Nm)

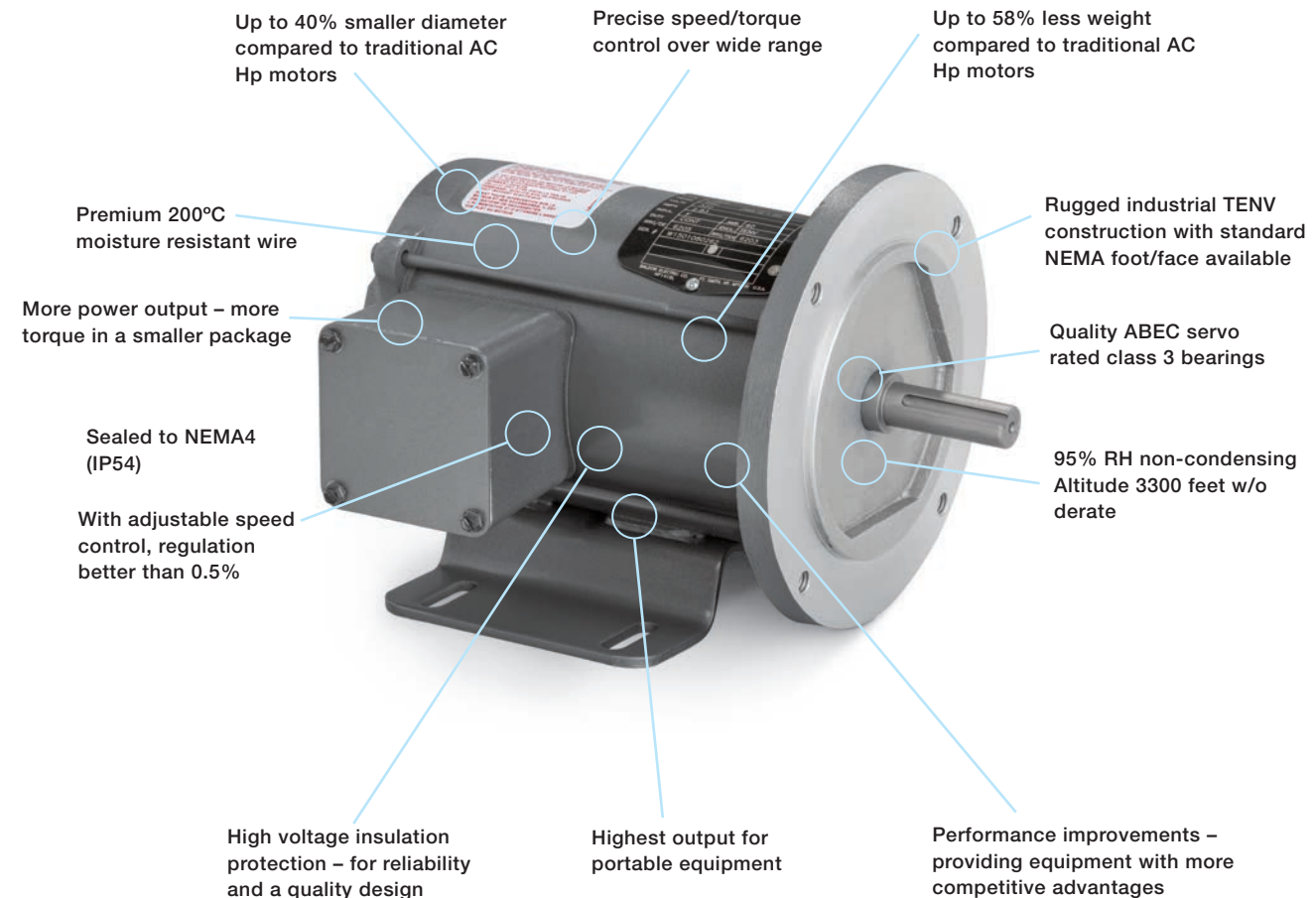

Typical BSM33 series shown

AC servo motors

BSM 25 & 33 series

The BSM 25/33 series allows many applications to make use of the advantages of brushless technology, including higher torque in smaller packages, quieter operation, and less maintenance. They have a continuous stall torque range from 18.6 lb-in (2Nm) to 138 lb-in (15.6 Nm) with available peak torques of 3 times continuous. This series will increase productivity while providing reliability and durability. It provides equipment with more competitive advantages in your market.



Brushless motors – BSM 25 & 33 series

4

Continuous stall torque		Continuous stall amps	Speed RPM @ 320V ¹	HP @ 1800 RPM	Motor number ²	Motor inertia	
lb-in	Nm					lb-in-s ²	Kg - cm ²
18.6	2.1	1.5	1800	1/4 HP	BSM25C-1177MHC	0.00241	2.72
23.0	2.6	1.90	1800	1/2 HP	BSM25C-2177MHC	0.0028	3.16
27.4	3.1	2.55	1800	1/2 HP	BSM33C-2177MHQ	0.00374	4.22
35.4	4	3.16	1800	1 HP	BSM33C-3177MHQ	0.00536	6.05
79.7	9	6.47	1800	1.5	BSM33C-4177MHQ	0.01033	11.66
99.1	11.2	9.15	1800	2 HP	BSM33C-5177MHQ	0.01212	13.68
138.1	15.6	14.23	1800	3 HP	BSM33C-6177MHQ	0.01859	20.99

Note: ¹ Nominal rpm shown at 320 Vdc bus for convenience. For 640 Vdc double the speed. Reference motor table to verify that max speed is not exceeded.

² Motors shown with these options for convenience: H = Hall Sensor, C = Round face only, Q = Foot & Round Face.

For other options see BSM25/33 ID matrix under engineering information.

AC servo motors

BSM 25 & 33 series performance curves

BSM25C-1177MHC

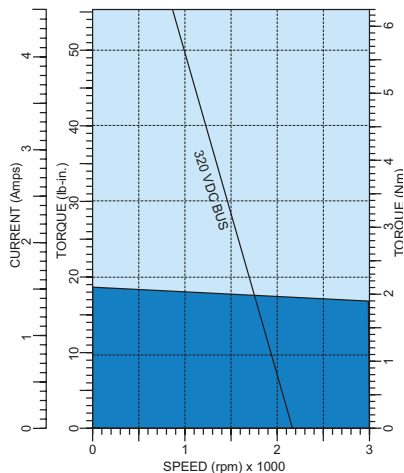

BSM25C-2177MHC

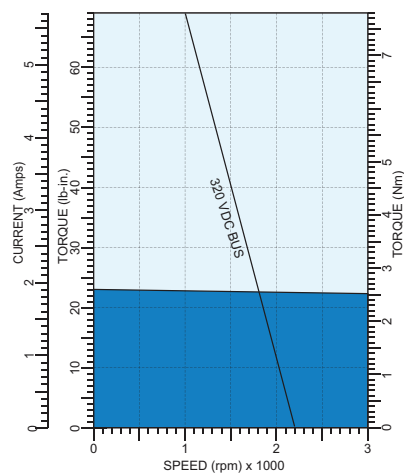

Model number		BSM25C-1177MHC	BSM25C-2177MHC
General			
Continuous stall torque	lb-in	18.6	23
	Nm	2.1	2.6
Continuous current	amps	1.5	1.9
Peak torque	lb-in	55.8	69
	Nm	6.3	7.8
Peak current	amps	4.5	5.7
Thermal resistance	°C/watt	1.44	1.24
Thermal time constant	Min	24	26.2
Mechanical time constant	msec	2.38	2.1
Electrical time constant	msec	3.98	3.73
Rated speed @ 300 volts	rpm	1800	1800
Rated speed @ 160 volts	rpm	900	900
Electrical			
Torque constant	lb-in/amp	15.5	15.1
	Nm/amp	1.75	1.71
Voltage constant	Vpk/krpm	150	146.5
	Vrms/krpm	106.1	103.6
Resistance	ohms	26.7	19.4
Inductance	mH	106.3	72.3
Mechanical			
Inertia	lb-in-s ²	0.00241	0.0028
	Kg-cm ²	2.72	3.16
Maximum speed	rpm	7,000	7,000
Number of motor poles	—	4	4
Weight	lbs/Kg	11.1/5.0	14.4/6.5

AC servo motors

BSM 25 & 33 series performance curves

BSM33C-2177MHQ

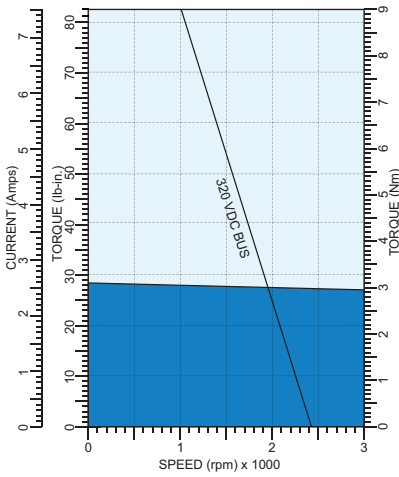

BSM33C-3177MHQ

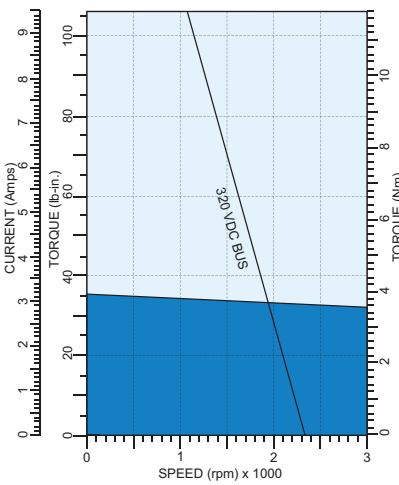

BSM33C-4177MHQ

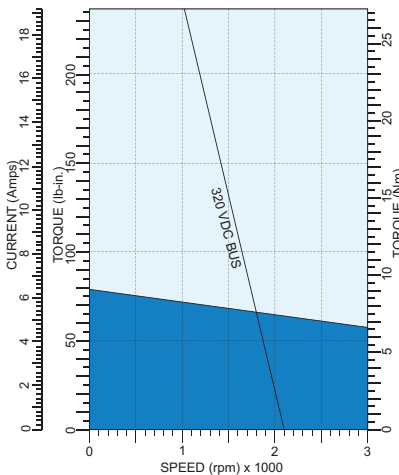

Model number		BSM33C-2177MHQ	BSM33C-3177MHQ	BSM33C-4177MHQ
General				
Continuous stall torque	lb-in	27.4	35.4	79.7
	Nm	3.1	4	9
Continuous current	amps	2.55	3.16	6.47
Peak torque	lb-in	82.3	106.2	239
	Nm	9.3	12	27
Peak current	amps	7.6	9.5	19.4
Thermal resistance	°C/watt	1.17	1.1	0.69
Thermal time constant	Min	27.8	29.5	33.9
Mechanical time constant	msec	2.09	1.92	1.16
Electrical time constant	msec	3.81	4.37	5.75
Rated speed @ 300 volts	rpm	1800	1800	1800
Rated speed @ 160 volts	rpm	900	900	900
Electrical				
Torque constant	lb-in/amp	13.5	14	15.4
	Nm/amp	1.52	1.58	1.74
Voltage constant	Vpk/krpm	131.5	136.3	151.3
	Vrms/krpm	93	96.4	107
Resistance	ohms	11.4	7.88	3.37
Inductance	mH	45.7	34.4	17.2
Mechanical				
Inertia	lb-in-s ²	0.00374	0.00536	0.01033
	Kg-cm ²	4.22	6.05	11.66
Maximum speed	rpm	7,000	7,000	7,000
Number of motor poles	—	8	8	8
Weight	lbs/Kg	14.9/6.8	17.3/7.9	25.3/11.5

AC servo motors

BSM 25 & 33 series performance curves

BSM33C-5177MHQ

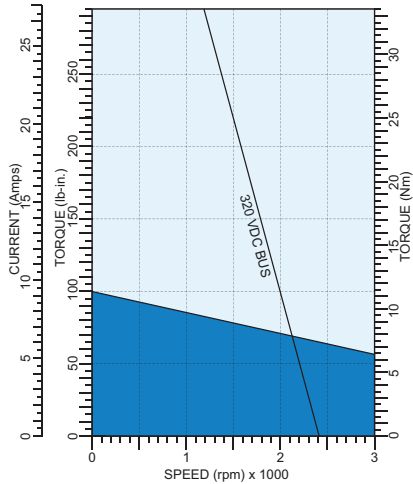

BSM33C-6177MHQ

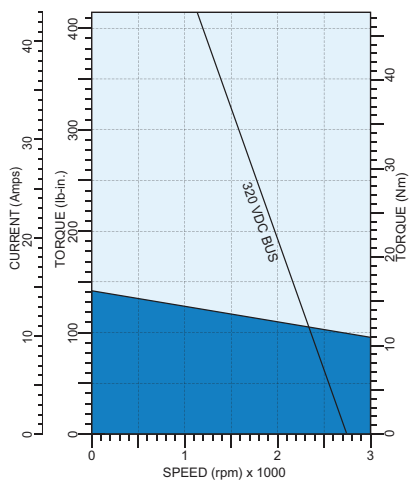

Model number		BSM33C-5177MHQ	BSM33C-6177MHQ
General			
Continuous stall torque	lb-in	99.1	138.1
	Nm	11.2	15.6
Continuous current	amps	9.15	14.23
Peak torque	lb-in	297.4	414.2
	Nm	33.6	46.8
Peak current	amps	27.5	42.7
Thermal resistance	°C/watt	0.52	0.52
Thermal time constant	Min	39.8	59.5
Mechanical time constant	msec	1.2	0.9
Electrical time constant	msec	5.83	6.8
Rated speed @ 300 volts	rpm	1800	1800
Rated speed @ 160 volts	rpm	900	900
Electrical			
Torque constant	lb-in/amp	13.5	12.1
	Nm/amp	1.53	1.37
Voltage constant	Vpk/krpm	131.1	117.4
	Vrms/krpm	92.7	83
Resistance	ohms	2.04	1.0
Inductance	mH	11.9	5.2
Mechanical			
Inertia	lb-in-s ²	0.01212	0.01859
	Kg-cm ²	13.68	20.99
Maximum speed	rpm	7,000	7,000
Number of motor poles	—	8	8
Weight	lbs/Kg	30.4/13.8	40.2/18.3

AC servo motors

BSM25 & 33 motors dimensions - NEMA mountings

BSM25 series

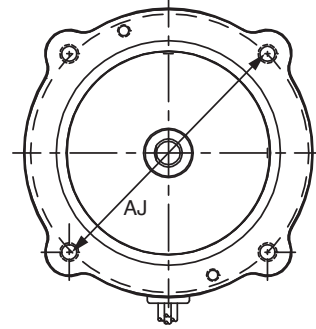
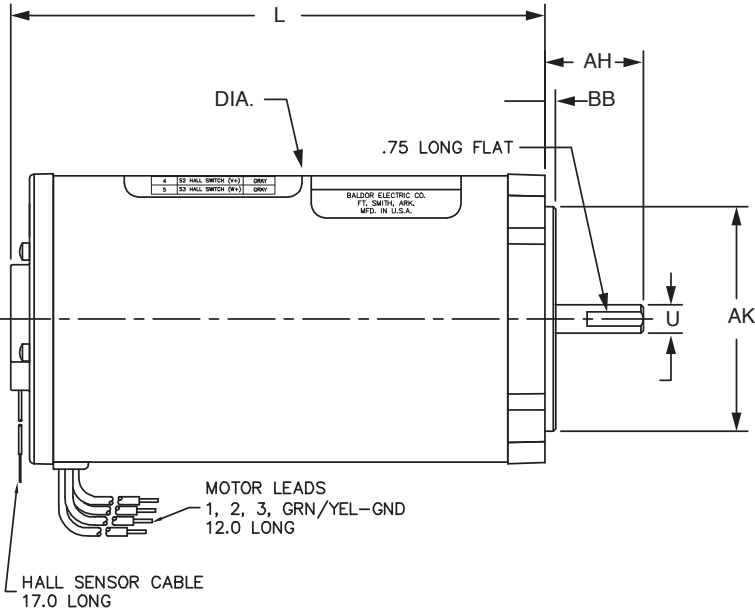

BSM33 series

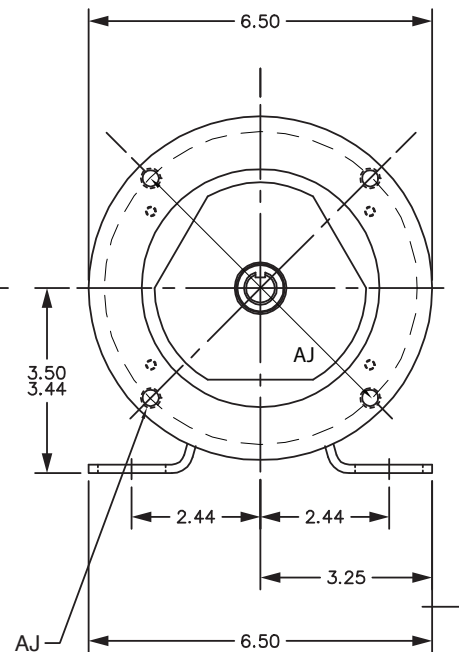
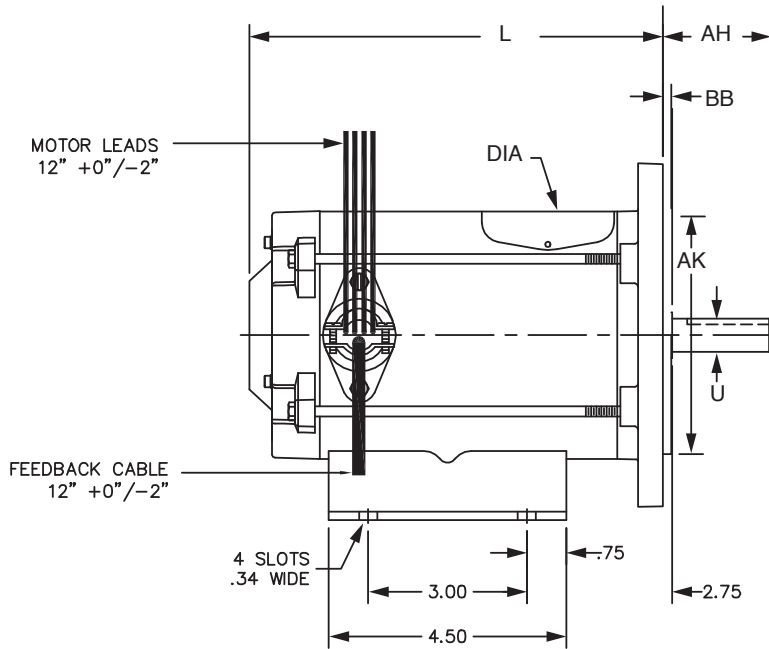

AC servo motors

BSM25/33 series dimensions - NEMA dimensions

Dimensions in inch (mm)

Motor code	Configuration	Body dia	U	AH	Key	AJ	AK	BB
BSM25C	42C face	3.88 (98.5)	0.375 (9.5)	1.31 (33.2)	0.75	4x 1/4-20 UNC-2B on a 3.75 B.C.	3 (76.2)	0.14 (3.5)
BSM33C	56C face	4.66 (118)	0.625 (15.8)	2.05 (52.07)	0.19 x 1.38	4x 0.38-16 tap on 5.875 B.C.	4.5 (114)	0.13 (3.3)

Motor code	Length - L		
	Hall	Encoder	Resolver
BSM25C-1	6.64 (169)	-	-
BSM25C-2	7.1 (180)	-	-
BSM33C-2	7.8 (198)	8.56 (217)	7.8 (198)
BSM33C-3	7.8 (198)	8.56 (217)	7.8 (198)
BSM33C-4	10.1 (257)	10.81 (275)	10.1 (257)
BSM33C-5	13.1 (333)	13.81 (351)	13.1 (333)
BSM33C-6	13.1 (333)	13.81 (351)	13.1 (333)

Note: Standard configuration: All motors supplied with Hall sensors and flying leads.
 BSM25 has NEMA 42C face; power leads 12" (304mm); Hall sensor leads 17" (431mm)
 BSM33 has NEMA 56C face/foot; power leads 12" (304mm); Hall sensor leads 12" (304)
 Dimensions are for reference only and may change for other selected options. Detailed engineering drawings available upon request

AC servo motors

Engineering information

[Brushless motor ID matrix for BSM N and C series](#)

[Brushless motor ID matrix for BSM25 and 33 series](#)

[Speed torque curves](#)

[How to interpret motor Information](#)

[Thrust and radial load](#)

5 [Motor connection diagrams](#)

[BSM mating connectors](#)

[Resolver specifications](#)

[Encoder specifications](#)

[Brake data for BSM and SSBSM](#)

[Servo motor selection](#)

[Servo motor requirement sheet](#)

[Conversion tables](#)

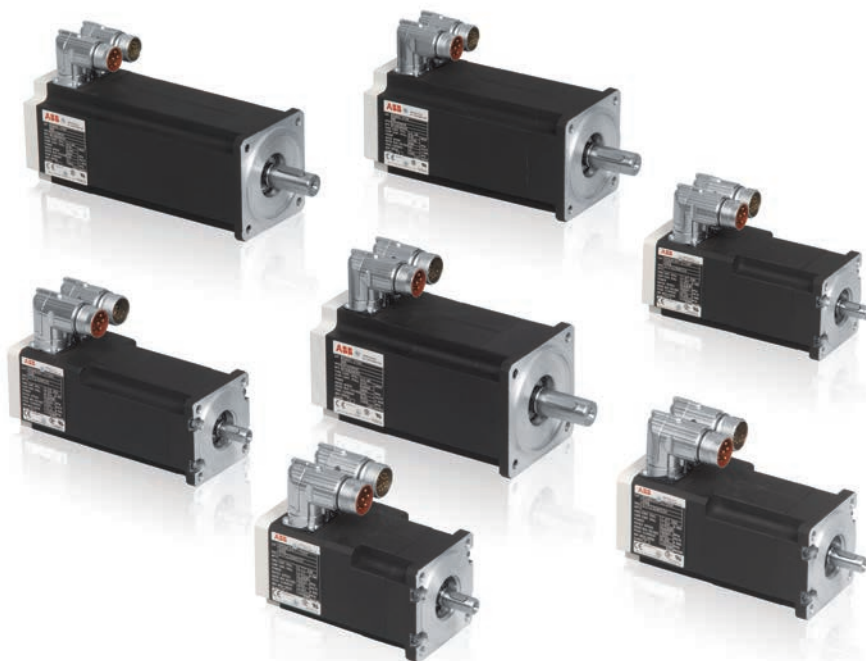

AC servo motors

Brushless servo motor identification matrix N and C series

		B	S	M											
		Frame			Series			Motor size		Winding code					
Blank = Std															
SS = Stainless steel		IEC	NEMA		N			1		50					
Note: Not all options are available on all motors. Contact your local District Office.		50	5N		C			2		75					
		63	6N					3		etc.					
		80	8N					4							
		90	9N												
		100	10 N												
		132													

Motor options

Description	Connections				
	Standard (metric) threaded style	Cables ⁶	Optional (inch) quick connect	Flying leads ⁶	Rotate-able (metric) threaded ⁹
Motor (no shaft seal)	A	E	I	M	R
Motor and brake	B	F	J	N	S
Motor with shaft oil seal	C	G	K	O	T
Motor with brake & shaft oil seal	D	H	L	P	U

Feedback options

- A = Resolver
- B = Absolute encoder – single-turn (BiSS)
- B2 = Absolute encoder – multi-turn (BiSS)
- D = Absolute encoder – multi-turn (EnDat)
- D2 = Absolute encoder – single-turn (EnDat)
- D3 = Absolute encoder – single-turn (Hiperface)
- D4 = Absolute encoder – multi-turn (Hiperface)
- S1 = Absolute encoder – single-turn (SSI)
- S2 = Absolute encoder – multi-turn (SSI)
- E = Incremental encoder w/ commutation (1000 ppr)
- F = Incremental encoder w/ commutation (2500 ppr)
- H = Halls only
- V = Encoder mounting only
- Y = Resolver mounting only

Accessory options

- Blank = No option
- M = No keyway
- N = DIN 42955-R
- O = DIN 42955-R & no keyway
- P = Optional motor connector on BSM 90/100 (Note: This option available only if current less than 28 amps)
- X = Special option (order by spec no. only)
- Z1 = Blower (115 VAC) (not available on all motors)
- Z2 = Blower (230 VAC) (not available on all motors)
- Z3 = Blower (24 Vdc)
- Z4 = Blower (230/460 VAC) for BSM132 only.

Note: ¹ The standard BSM50/63/80 series includes feedback, two threaded connectors for feedback and motor terminations, square mounting flange.
² The standard BSM90/100 series includes, one threaded connector for feedback termination, termination of motor lead wires on terminal block, square mounting flange.
³ BSM motors do not have shaft seal as standard. BSM motors are IP54. Motors will meet IP55 with shaft oil seal.
⁴ SSBSM motors available with IEC mounting and include as standard a shaft seal. SSBSM motors are IP67.
⁵ The standard BSM50 series has as standard no keyway.
⁶ Shielded cables and flying leads are one meter long as standard. Flying leads option is composed of individual wires with no armored protection.
⁷ Order motor power and feedback cable assemblies as separate items.
⁸ Motors may be used with 115/230/400/460 volt controls. Verify that maximum speed is not exceeded.
⁹ Rotatable connectors not available on BSM50-series. Standard rotatable on models up to BSM100 available (only if current is less than 28 amps). BSM132 requires a larger connector.
¹⁰ Pricing for NEMA versions 5N, 6N, 8N, 9N, and 10N is the same as IEC versions 50, 63, 80, 90, and 100.
¹¹ Contact your local ABB district office for special options.

AC servo motors

Brushless motors

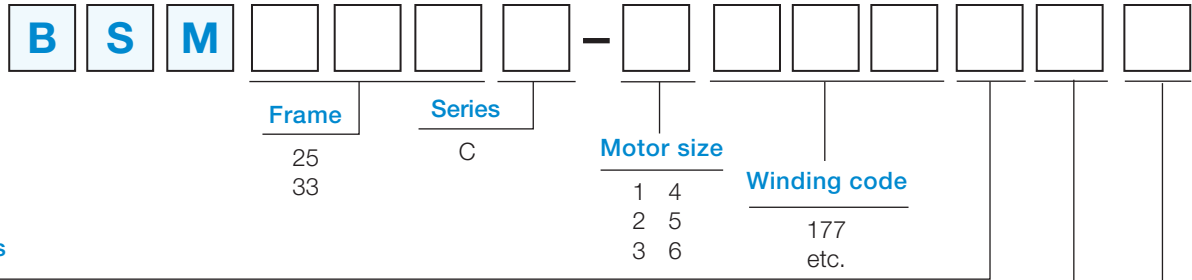

Motor options

Description	Connections		
	Flying leads	Rotatable feedback connector and motor terminal box	Conduit Box
Motor (no shaft seal)	M	R	A
Motor and brake	N	S	B
Motor with shaft oil seal	O	T	C
Motor with brake and shaft oil seal	P	U	D

Feedback options

- H = Halls
- A = Resolver
- E = Incremental encoder w/ commutation (1000 ppr)
- F = Incremental encoder w/ commutation (2500 ppr)
- N = No feedback

Accessory options

- Q = Foot and round face
- C = Round face only
- F = Foot mount
- C1 = 33 frame only IEC flange MTG
- C2 = 33 frame only IEC face MTG

AC servo motors

Speed – torque curves how to read motor performance curves

We have provided the following curves in order to simplify the process of selecting both a motor and control for a specific application. The following paragraphs explain how the information in these curves should be interpreted.

In constant speed applications, motors are defined in terms of horsepower or kilowatts (which is torque at a base speed). Servo motors normally operate over a wide speed range. The curves show continuous torque (defined as torque which will not overheat the motor), and peak torque (defined as intermittent acceleration torque).

It is also necessary to know the current and voltage required for the motor to operate. The curves have a scale that shows current required for any torque, and voltage required for any speed.

As an example, an application requires a continuous torque of 25 lb-in (2.8 Nm) at a speed of 1000 RPM. The peak torque required for acceleration is 80 lb-in (9 Nm).

This curve shows that the motor will work in this application. The bus voltage required is 160Vdc. The continuous and peak currents required is 3.5 and 12 amps.

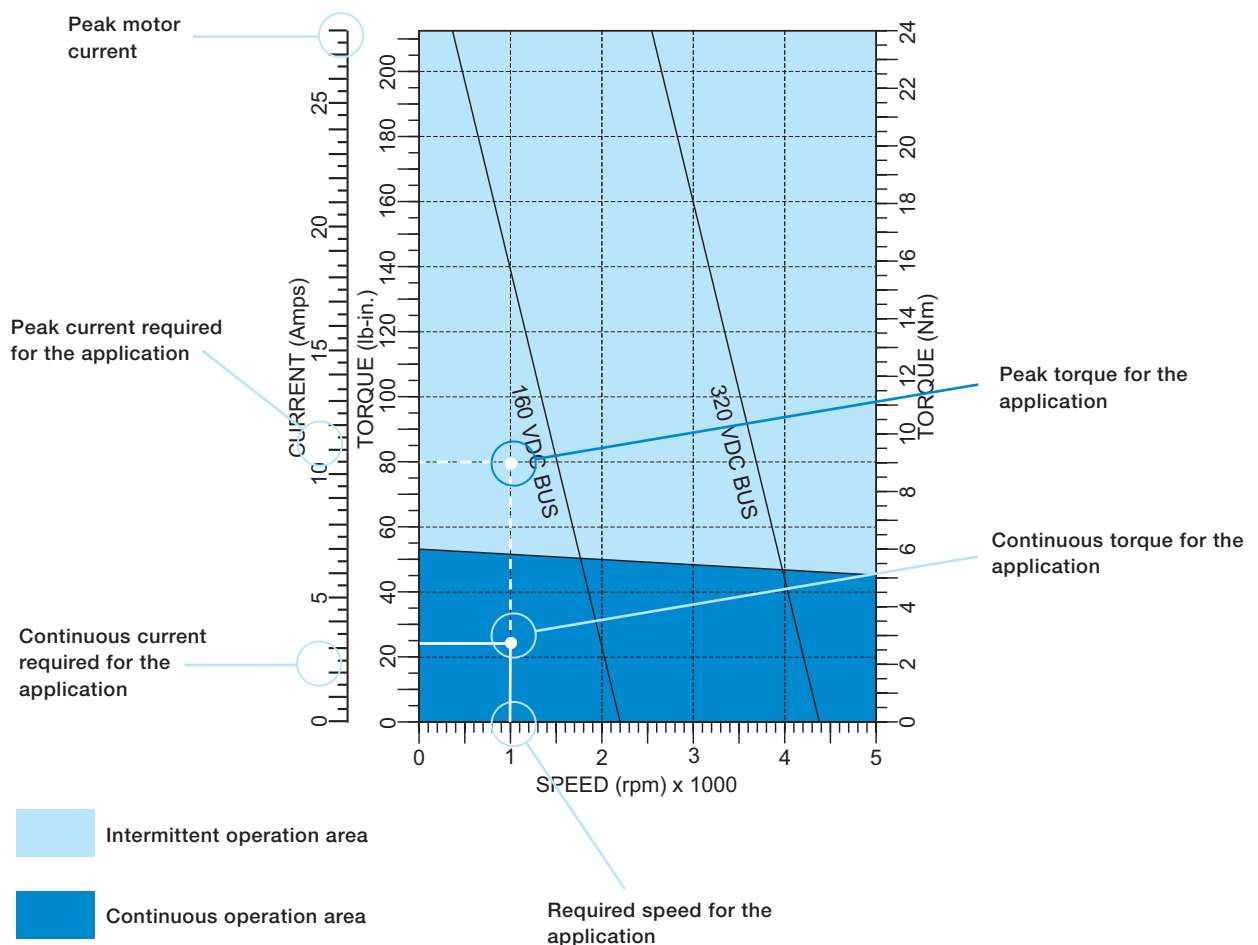

AC servo motors

How to interpret motor information

“Rated” voltage/speed

“Rated” conditions refer to measurement points, and are selected as an easy and convenient “reference” or “measurement” point. Manufacturers select a “rated voltage”, operate with a “rated torque”, to verify that “rated speed” is reached.

Note that any voltage may be applied to the BSM series of brushless servo motors so either 160 Vdc, 300 Vdc, or 650 Vdc may be applied. However the design limits must be observed. And those are: 1) maximum speed (rpm) limit, 2) demagnetization (max torque/current) limit, and 3) 650 Vdc maximum.

Motor data

All BSM motors are 3-phase WYE connected. Connection is important because the motor/feedback is phase sensitive. All motor parameters are expressed as phase to phase (line-to-line) figures. This includes voltage constant, resistance and inductance.

5

The phase to phase voltage constant (back-emf) is a sinusoidal wave, which is measured while driving the motor (as a generator) at 1000 rpm, and measuring the output voltage. The peak of this measured output voltage is shown in the literature as $V_{pk}/krpm$; the RMS of the output voltage is $V_{rms}/krpm$.

Some data in the motor tables are expressed as “cold” figures (25°C), while others are “hot” (155°C) values. The cold figures are: voltage constant, torque constant, resistance, inductance, peak torque and peak current. The hot figures are: continuous stall torque continuous stall current.

The temperature coefficient between cold and hot voltage constant (and torque constant) is 0.90 for N-series, 0.80 for C-series and 0.85 for BSM132 series. Motor resistance changes by a factor of 1.5 from 25°C to 155°C.

Motor temperature

The BSM series of servo motors are rated for a maximum continuous winding temperature of 155°C. These conditions are plotted in a 25°C ambient on the motor speed-torque curves. For operation at 40°C ambient derate by 6%.

The temperature rise of the motor windings depends upon the amount of torque which is being delivered to the load. In this brochure, the thermal limit line (line dividing dark and light shaded areas on the speed-torque curves) indicates the 155°C limit.

Temperature range - normal operating range of bearing grease is - 29°C to 155°C.

Altitude - the motors are rated for operation at 1000m or lower; derate 10% per 1000m.

The BSM motors include an internal thermal switch (bi-metallic) which is normally closed. It opens at 155°C $\pm 5^\circ$. This switch may be connected to the input of a motion controller, programmable logic device, or other type of machine control via an isolating relay. Any of these devices could then sense this switch and shut power down when the thermal switch opens.

AC servo motors

Thrust load capacity

Brushless servo motors
Thrust load capacities

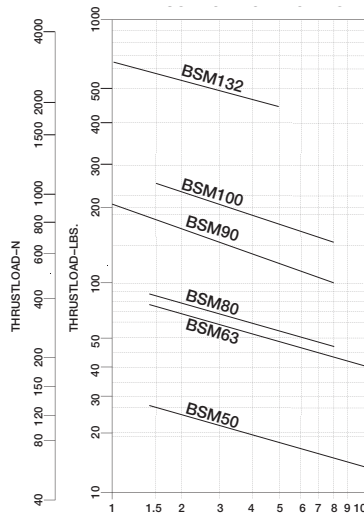

Radial load capacity

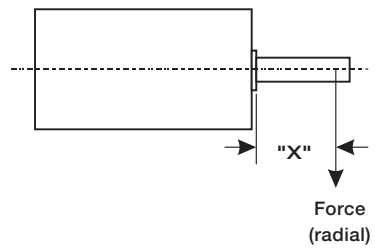
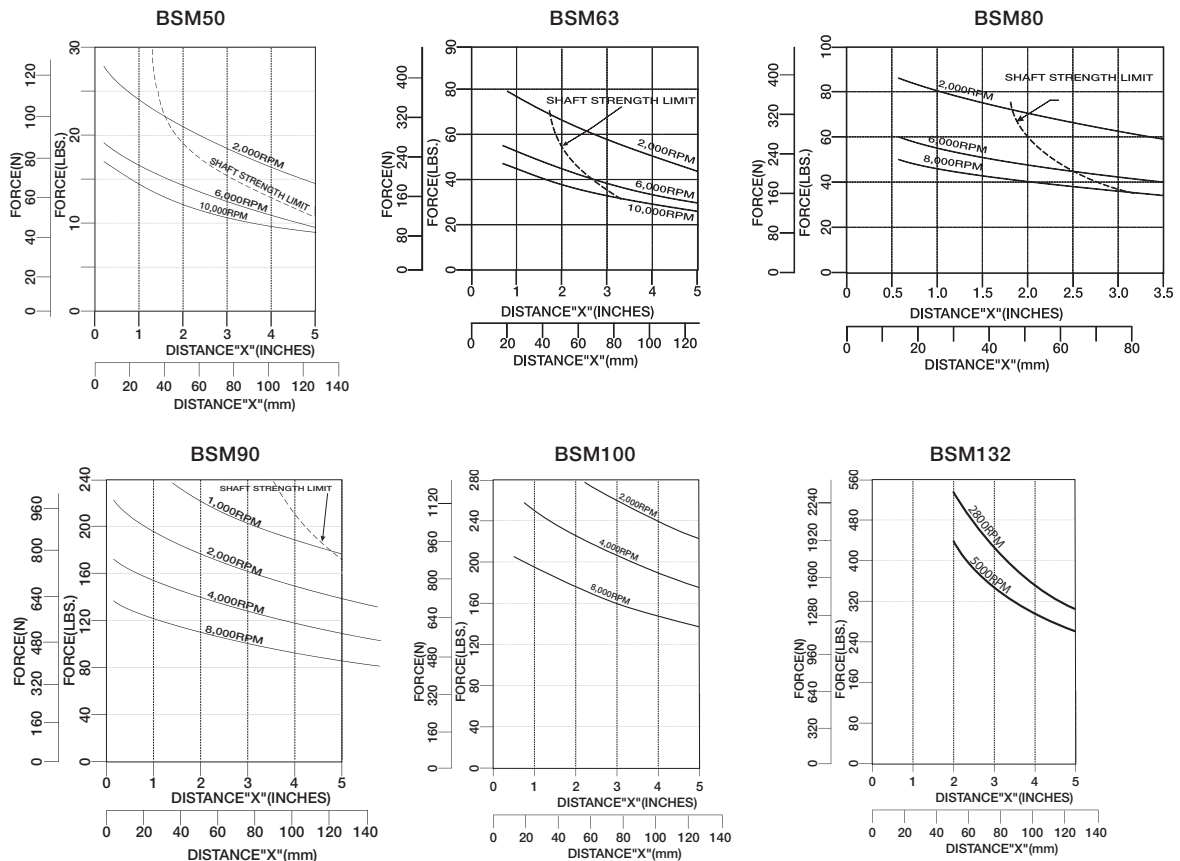

- Notes :
- 1) Solid lines are based on L10 = 20,000 hours.
 - 2) Dashed line is based on 104 load peaks @ 110% of rated torque.
 - 3) L10 is a failure rate measure given in time period before 10% failure.

AC servo motors

Motor connection diagrams

Motor-Resolver

BSMxxx-xxxxA

Terminal block

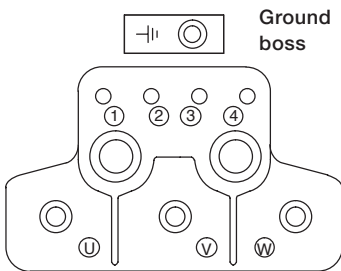

Power connections BSM 90/100

Post	Function
1	Thermal switch
2	Thermal switch
3	Brake (optional)
4	Brake (optional)
U1	Motor lead U
V2	Motor lead V
W3	Motor lead W
Screw	Ground

Motor-Incremental encoder

BSMxxx-xxxxF or E

Terminal block

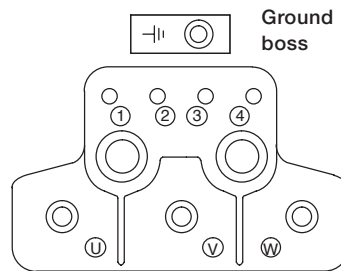

Power connections BSM 90/100

Post	Function
1	Thermal switch
2	Thermal switch
3	Brake (optional)
4	Brake (optional)
U1	Motor lead U
V2	Motor lead V
W3	Motor lead W
Screw	Ground

5

Standard and rotatable connectors

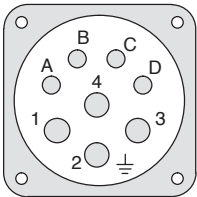

Power connections BSM 50/63/80 and SSBSM

Post	Function
A	Thermal switch
B	Thermal switch
C	Brake (optional)
D	Brake (optional)
1	Motor lead U
2	Ground
3	Motor lead W
4	Motor lead V

Standard motor connector

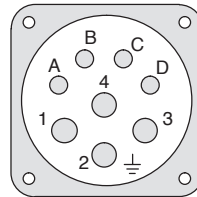

Power connections BSM 50/63/80 and SSBSM

Post	Function
A	Thermal switch
B	Thermal switch
C	Brake (optional)
D	Brake (optional)
1	Motor lead U
2	Ground
3	Motor lead W
4	Motor lead V

Standard and rotatable connectors

12 Pin

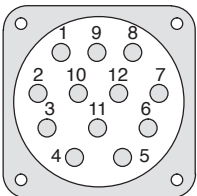

Resolver connections BSM and SSBSM

Post	Function
1	REF HI R1
2	REF LO R2
3	COS+ S1
4	COS- S3
5	SINE- S4
6	SINE+ S2
7-12	No connection

Standard encoder connector

16 pin

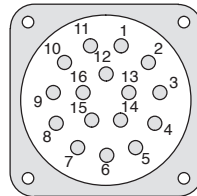

Encoder connections BSM and SSBSM

Post	Function
1	DC + 5V
2	Ground
3	Channel A
4	Channel <u>A</u>
5	Channel B
6	Channel <u>B</u>
7	Channel Z
8	Channel <u>Z</u>
9	Open
10	Channel U
11	Channel <u>U</u>
12	Channel V
13	Channel <u>V</u>
14	Channel W
15	Channel <u>W</u>
16	No connection

Note: For BSM 50/63/80 (and option on BSM90/100), the standard and rotatable power connector is rated at 28 amps. BSM brakes are not polarity sensitive.

AC servo motors

Motor connection diagrams

Motor-BiSS

BSMxxx-xxxxB or B2

Motor-EnDat

BSMxxx-xxxxD2 or D

Terminal block

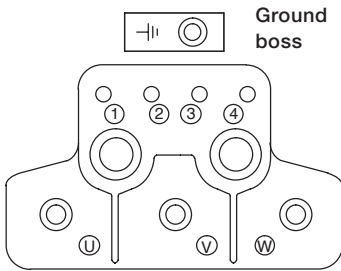

Power connections BSM 90/100

Post	Function
1	Thermal switch
2	Thermal switch
3	Brake (optional)
4	Brake (optional)
U1	Motor lead U
V2	Motor lead V
W3	Motor lead W
Screw	Ground

Terminal block

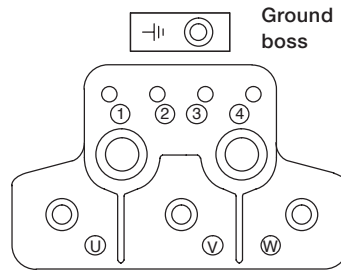

Power connections BSM 90/100

Post	Function
1	Thermal switch
2	Thermal switch
3	Brake (optional)
4	Brake (optional)
U1	Motor lead U
V2	Motor lead V
W3	Motor lead W
Screw	Ground

Standard motor connector

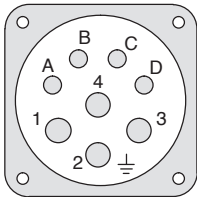

Power connections BSM 50/63/80 and SSBSM

Post	Function
A	Thermal switch
B	Thermal switch
C	Brake (optional)
D	Brake (optional)
1	Motor lead U
2	Ground
3	Motor lead W
4	Motor lead V

Standard motor connector

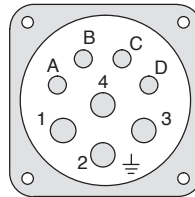

Power connections BSM 50/63/80 and SSBSM

Post	Function
A	Thermal switch
B	Thermal switch
C	Brake (optional)
D	Brake (optional)
1	Motor lead U
2	Ground
3	Motor lead W
4	Motor lead V

Standard BiSS connector

12 Pin

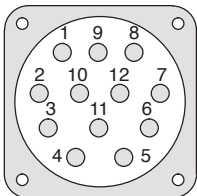

BiSS connections BSM and SSBSM

Post	Function
1	DATA-
2	A+ (SIN+)
3	0V sensor
4	B+ (COS+)
5	Clock-
6	—
7	Clock+
8	B- (COS-)
9	5V & up sense
10	0V DGND
11	A- (SIN-)
12	DATA+

Standard EnDat connector

12 Pin

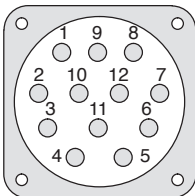

EnDat connections BSM and SSBSM

Post	Function
1	DATA-
2	SIN A+
3	0V sensor
4	COS B+
5	Clock -
6	5V sensor
7	Clock +
8	COS B-
9	+5V
10	DGND
11	SIN A-
12	DATA+

Note: For BSM 50/63/80 (and option on BSM90/100), the power connector is rated at 28 amps. BSM brakes are not polarity sensitive.

AC servo motors

Motor connection diagrams

Motor-SSi BSMxxx-xxxxS1 or S2

Motor-Hiperface BSMxxx-xxxxD3 or D4

Terminal block

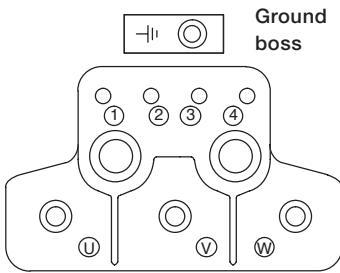

Power connections BSM 90/100

Post	Function
1	Thermal switch
2	Thermal switch
3	Brake (optional)
4	Brake (optional)
U1	Motor lead U
V2	Motor lead V
W3	Motor lead W
Screw	Ground

Terminal block

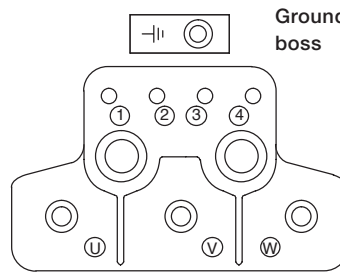

Power connections BSM 90/100

Post	Function
1	Thermal switch
2	Thermal switch
3	Brake (optional)
4	Brake (optional)
U1	Motor lead U
V2	Motor lead V
W3	Motor lead W
Screw	Ground

Standard motor connector

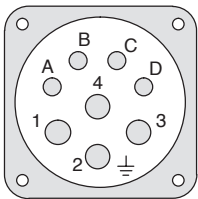

Power connections BSM 50/63/80 and SSBSM

Post	Function
A	Thermal switch
B	Thermal switch
C	Brake (optional)
D	Brake (optional)
1	Motor lead U
2	Ground
3	Motor lead W
4	Motor lead V

Standard motor connector

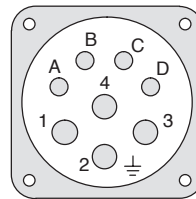

Power connections BSM 50/63/80 and SSBSM

Post	Function
A	Thermal switch
B	Thermal switch
C	Brake (optional)
D	Brake (optional)
1	Motor lead U
2	Ground
3	Motor lead W
4	Motor lead V

Standard SSI connector 12 Pin

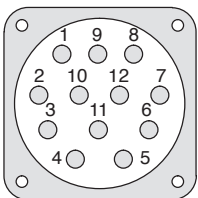

SSI connections BSM and SSBSM

Post	Function
1	+Vs (5Vdc)
2	0V
3	SSI clock
4	SSI clock
5	SSI DATA
6	SSI DATA
7	-
8	-
9	Connected to pin 1
10	-
11	-
12	-

Standard hiperface connector 12 Pin

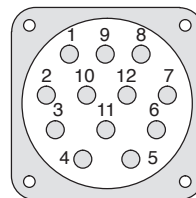

Hyperface connections BSM and SSBSM

Post	Function
1	DATA-
2	+SIN
3	Open
4	+COS
5	OPEN
6	OPEN
7	OPEN
8	REF COS
9	US 7-12V
10	GND
11	REF SIN
12	DATA+

Note: For BSM 50/63/80 (and option on BSM90/100), the power connector is rated at 28 amps. BSM brakes are not polarity sensitive.

AC servo motors

Motor connection diagrams

Motor – Halls BSM25C–xxxxMHx

Flying leads

Power connections BSM25C

Wire color	Function
1 (T1)	U
2 (T2)	V
3 (T3)	W
Green/yellow	Ground

Flying leads

Hall connections BSM25C

Wire color	Function
White	S1 hall switch
Yellow	S2 hall switch
Orange	S3 hall switch
Red	VCC+
Black	Ground

Motor – Halls

BSM33C–xxxxMHx

Flying leads

Power connections BSM33C

Wire color	Function
Yellow or blue	Thermal switch*
Yellow or blue	Thermal switch*
Black	U
Red	V
Blue	W
Green/yellow	Ground

*When required

Flying leads

Hall connections BSM33C

Wire color	Function
Blue	S1 hall switch (U+)
Brown	S2 hall switch (V+)
Blue/white	S3 hall switch (W+)
Red	VCC+
Black	Ground

Note: BSM/SSBSM 50/63/80 series require both power and feedback cables. Refer to BR1202-H for cable assemblies.

AC servo motors

Feedback specifications

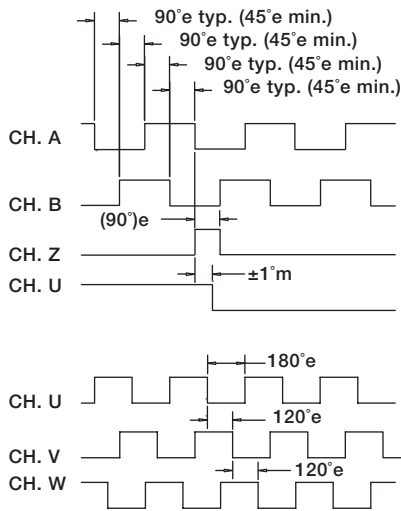
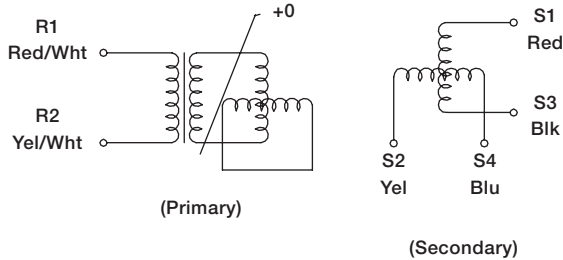

BRUSHLESS D.C. COMMUTATION

8 POLE MECH. DEGREES	0	15	30	45	60	75	90	105	120	135	150	165	180
4 POLE MECH. DEGREES	0	30	60	90	120	150	180	210	240	270	300	330	360
ELECTRICAL DEGREES	0	60	120	180	240	300	360	420	480	540	600	660	720

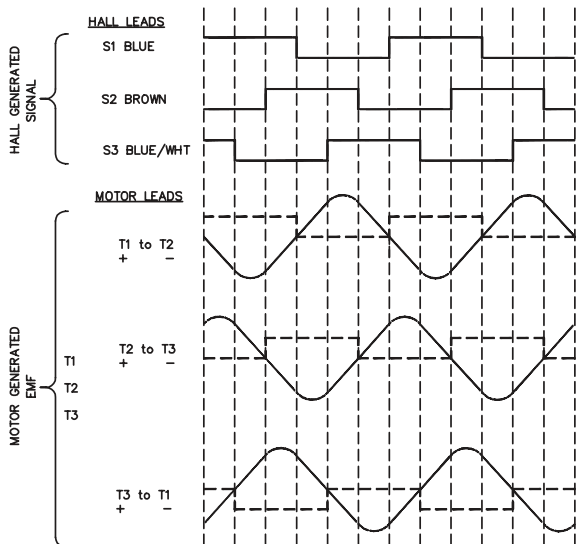

Resolver specifications

Power source	AC 10Vrms / 4.5 kHz	
Primary element	Rotor	
Electrical error	±7	
Resolver speed	1	
Transformation ratio	0.5±10%	
Phase shift	+ 8° Nominal	
Accuracy spread	12 Arc Minutes	
Input impedance	ZRO	90 + j180 Nominal
Output impedance	ZSO	220 + j350 Nominal at 0° (S1-S3)
	ZSS	210 + j300 Nominal at 0° (S1-S3)
D.C. resistance	ROTOR	46 Ref
	STATOR	120 Ref
Dielectric strength	AC500 Volts 1 Minute 60 (50) Hz	
Insulation resistance	100 M Min DC 500 Volts	
Weight	0.18 kg Max	
Max operating speed	10,000 Min	
Operating temperature range	-55° C to +150° C	
Output equation	ES1 - S3 KE R1-R2 COS ES2 - S4 KE R1-R2 SIN	

Encoder specifications

Power in	5V
Output	Line driver Incremental 2 channel Index Hall output (4 or 8 pole)
PPR	STD 2500 ppr Contact ABB for other options
Maximum Electrical Frequency	1000/2500 ppr 200 kHz/300kHz
Hall output	BSM/SSBSM 50/63/80 series use 4 pole Hall output. 90/100 series use 8 pole Hall output.
Operating temperature range	-20° C to +120° C

Hall sensor specifications

Power In	3.8–30 Vdc
Output	Hall output (4 or 8 pole)

AC servo motors

Motor mating connectors

Termination	Motor type	Description	Number
Motor power	BSM50/63/80/90/100	Mate assy power CE threaded connector (28 amp) (8 pin)	MCSPOW-08
	BSM132	Mate assy rotatable power (70 amp)	C/F
	SSBSM	Mate assy power stainless steel threaded conn (28 amp)	MCSPOW-08S
Strain relief	BSM90/100	PG21 strain relief	MCS-PG21
		PG29 strain relief	ASR24661
		Adaptor (PG29 to PG21)	ASR24662
		M40 strain relief	MCS-M40
		Adaptor (M40 to M25)	MCS-M40A
Resolver, BiSS,	BSM50/63/80/90/100/132	Mate assy feedback CE threaded connector (12 pin)	MCSRES-12
SSI, hyperface,	SSBSM	Mate assy feedback threaded conn stainless steel	MCSRES-12S
EnDat	BSM - F-series	F-series resolver mate assy (14 pin)	MCSN
Encoder	BSM50/63/80/90/100/132	Mate assy encoder CE threaded connector (16 pin)	MCSENC-16
	SSBSM	Mate assy encoder threaded conn stainless steel	MCSENC-16S

Note: BSM/SSBSM 50/63/80 series require both power and feedback cables. Refer to BR1202-H for cable assemblies.

Flange adaptor kits

Order number	Description
2R-BSM63	Kit for BSM63 to convert to old equivalent 2R mounting [thickness = 0.416 inch (10.5mm)]
3R-BSM80	Kit for BSM80 to convert to old equivalent 3R mounting [thickness = 0.561 inch (14.2mm)]
4R-BSM90	Kit for BSM90 to convert to old equivalent 4R mounting [thickness = 0.804 inch (20.4mm)]
56-BSM90	Kit for BSM90 to convert to 56 mounting [thickness = 0.952 inch (24mm)]
6R-BSM100	Kit for BSM100 to convert to old equivalent 6R mounting [thickness = 0.647 inch (16.4mm)]

Note: The standard shaft extension will be reduced by the thickness of the above kit adapter flange. If desired, a custom motor may be ordered with shaft length appropriate for mounting. Dimensions are nominal.

Brake data for BSM and SSBSM

Motor code	Brake holding torque Nm (lb-in)	Watts	Brake voltage (Vdc)	Brake current (amps)	Brake times (msec)		Brake inertia	
					Set	Release	(lb-in-s ²)	(Kg-cm ²)
BSM50N	1.1 (10)	10.1	24	0.5	3	20	0.000017	0.019
BSM63N	2 (18)	11.9	24	0.6	6	43	0.000016	0.018
BSM80	4.5 (40)	19.7	24	0.7	9	48	0.000111	0.125
BSM90	15.8 (140)	22.5	24	0.9	14	110	0.00016	0.181
BSM100	39.5 (350)	33.7	24	1.4	22	195	0.00064	0.723
BSM25C	1.7 (15)	10	24	0.4	16	27	0.00003	0.034
BSM33C	15.8 (140)	22	24	0.9	14	110	0.00016	0.181
BSM132C	101.7 (900)	76	24	3.16	129	163	0.01529	17.277

Note: All standard brakes used on BSM motors are 24 Vdc. The application needs to provide this voltage to release the brake. The brake is a safety brake only and not intended to be used to decelerate loads. Contact ABB for details. Detailed engineering drawings are available upon request.

AC servo motors

Servo motor selection

Calculating servo motor requirements

In selecting a motion control package, one of the areas requiring identification is the mechanics of the load which will be moved. Once this physical data is obtained, the proper matching of motor and control can easily begin.

The mechanics of the load involve both friction (which is easy to understand) and inertia (which is an unknown, since we have difficulty in recalling the physics we had in school).

5

The first part of the equation, determining friction of the load, can be accomplished by either estimating, or measuring by simply using a torque wrench.

The second part is determining the inertia. Inertia is the resistance of an object to be accelerated, or decelerated. In motion control, inertia is an important parameter since it defines the torque required to accelerate the load and get it into position.

If no one has told you what the inertia is, then to answer this question, you will have to do a calculation. However, once sufficient information is obtained, the task is relatively simple.

To determine the inertia, the mechanical linkage system which will be moved will be analyzed. These mechanical systems can be divided into four basic categories: direct drive, gear drive, tangential drive, and ballscrew drive.

In the following, each of these mechanical linkage categories and relevant formulas for calculating the load parameters will be presented. In all instances, the formulas reflect the load parameters as “seen” by the motor. Reflecting all these parameters back to the motor shaft make the calculation easier for selecting the motor and control for your motion control application.

Direct drive

Direct drive

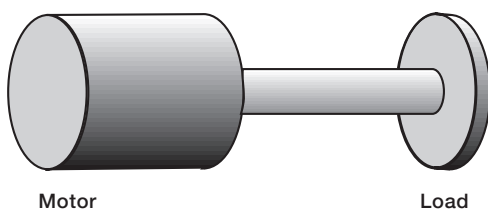

where

S_m = motor speed (rpm)

S_l = load speed (rpm)

T_m = motor torque

T_l = load torque

J_t = total inertia

J_l = load inertia

J_m = motor inertia

speed (motor) = speed (load)

$S_m = S_l$

torque at motor = torque at load

$T_m = T_l$

total inertia = inertia (load) + inertia (motor)

$J_t = J_l + J_m$

Figure 1

The simplest of packages is the first basic category, the direct drive. This would not require the load parameters to be reflected back, since there are no mechanical linkages involved.

The equations for the direct drive are presented in Figure 1. The speed of the load is the same as the motor, the friction of the load is the friction which the motor must overcome, and the load inertia is directly what the motor would “see”.

AC servo motors

Inertia

Solid cylinder:

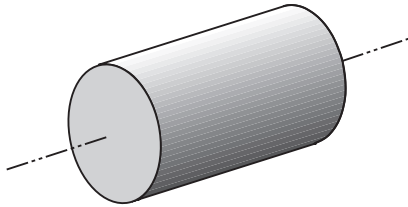

where

J = inertia
 W = weight
 R = radius
 g = gravitational constant (386 in/s²)(980 cm/s²)
 L = length
 p = density

For a known weight and radius:

$$J = \frac{1}{2} \frac{WR^2}{g}$$

For a known density, radius, and length:

$$J = \frac{1}{2} \frac{\pi L p R^4}{g}$$

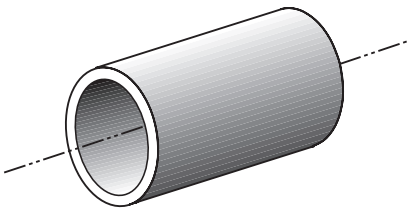

where

J = inertia
 W = weight
 Ro = outer radius
 Ri = inner radius
 g = gravitational constant (386 in/s²)(980 cm/s²)
 L = length
 p = density

For a known weight and radius

$$J = \frac{1}{2} \frac{W}{g} (Ro^2 + Ri^2)$$

For a known density, radius, and length:

$$J = \frac{1}{2} \frac{\pi L p}{g} (Ro^4 - Ri^4)$$

Material	Density (lb/in ³)	gm/cm ³
Aluminum	.098	2.72
Copper	.322	8.91
Plastic	.040	1.11
Steel	.280	7.78
Wood	.029	0.8

Figure 2

Inertia can be calculated if either the weight and radius are known; or the density, radius, and length are known. Figure 2 presents the equations.

As an example, if the cylinder were a lead screw with a radius of .312 inches (0.79 cm) and a length of 22 inches (55.8 cm), then the inertia would be:

$$J = \frac{1}{2} \frac{\pi L p R^4}{g} = \frac{1}{2} \frac{\pi (22) (.28) (.312)^4}{386} = 0.000237 \text{ lb-in-s}^2$$

$$\text{Metric} = \frac{1}{2} \frac{\pi (55.8) (7.75) (0.79)^4}{980} = 0.26 \text{ gm-cm-s}^2$$

These equations are important since the inertia of mechanical components (i.e. shafts, gears, drive rollers, leadscrews, etc.) can be calculated by using them. Once the inertia is determined, it becomes just a task of reflecting that load inertia and friction through the mechanical linkages to what the motor will “see”.

AC servo motors

Gear drive

Gear drive:

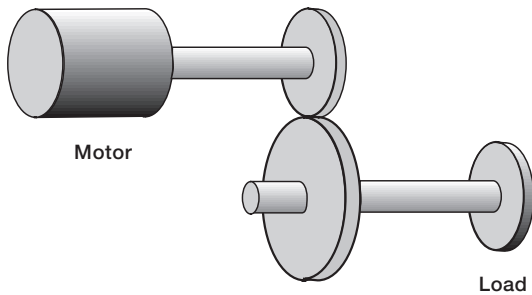

where

S_m = motor speed (rpm)
 S_l = load speed (rpm)
 N = gear ratio
 N_l = number of load gear teeth
 N_m = number of motor gear teeth
 T_m = motor torque
 T_l = load torque
 e = efficiency
 J_t = total inertia
 J_l = load inertia
 J_m = motor inertia

speed (motor) = speed (load) x gear ratio

$$S_m = S_l \times N$$

$$\text{or } S_m = S_l \times N_l \div N_m$$

torque at motor = torque at load ÷ gear ratio

$$T_m = \frac{T_l}{N_e}$$

total inertia = inertia (load) ÷ (gear ratio)² + inertia (motor)

$$J_t = \frac{J_l}{N^2} + J_m$$

Figure 3

In a gear application, since there are mechanical linkages between the load and motor, the load parameters must be reflected back to the motor shaft. Figure 3 presents the equations.

As an example, if a solid cylinder with a diameter of 4 inches (10.16 cm) and weighing 6 pounds (2718 gm) is connected thru a 3:1 gear, the reflected inertia would be determined by the following:

First, calculating inertia for a solid cylinder:

$$J_{\text{load}} = \frac{1}{2} \frac{WR^2}{g} = \frac{1}{2} \frac{6(2)^2}{386} = .031 \text{ lb-in-s}^2$$

$$\text{Metric} = \frac{1}{2} \frac{2718(5.08)^2}{980} = 35.7 \text{ gm-cm-s}^2$$

reflecting this inertia thru the gear ratio:

$$J_{\text{ref}} = \frac{J_{\text{load}}}{N^2} = \frac{.031}{(3)^2} = .0034 \text{ lb-in-s}^2$$

$$\text{Metric} = \frac{35.7}{(3)^2} = 3.96 \text{ gm-cm-s}^2$$

The total reflected load inertia which the motor would “see” would be .0034 lb-in-s² (or metric: 3.96 gm-cm-s²).

The inertia of the gears should be included in the determination of total load inertia to be really accurate (this can be obtained from literature or calculated using the formulas for the inertia of a cylinder). Efficiencies of the gearing should also be considered when calculating torques.

AC servo motors

Tangential drive

Tangential drive:

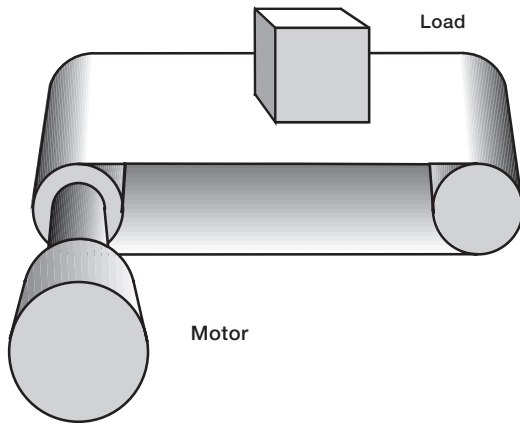

Figure 4

where

- Sm = motor speed (rpm)
- V_1 = load speed (in/min) (cm/min)
- R = radius
- T_1 = torque reflected to motor
- F_1 = load force
- T_f = friction torque
- F_f = friction force
- J_t = total inertia
- W = load weight + belt weight
- J_p = pulley inertia
- J_m = motor inertia
- g = gravitational constant (386 in/s²) (980 cm/s²)

$$\text{speed (motor)} = \frac{1}{2\pi} \times \frac{\text{speed (load)}}{\text{radius}}$$

$$Sm = \frac{1}{2\pi} \times \frac{V_1}{R}$$

$$\text{load torque} = \text{load force} \times \text{radius}$$

$$T_1 = F_1 R$$

$$\text{friction torque} = \text{frictional force} \times \text{radius}$$

$$T_f = F_f R$$

$$\begin{aligned} \text{total inertia} &= (\text{weight} \times \text{radius}^2) \div (\text{gravity}) \\ &+ \text{inertia (pulley \#1)} + \text{inertia (pulley \#2)} \\ &+ \text{inertia (motor)} \end{aligned}$$

$$J_t = \frac{W R^2}{g} + J_{p1} + J_{p2} + J_m$$

For this type of drive, the load parameters have to be reflected back to the motor shaft. A tangential drive can be a timing belt and pulley, chain and sprocket, or rack and pinion. See Figure 4 for formulas.

As an example, a belt and pulley arrangement will be moving a weight of 10 lbs (4530 gm). The pulleys are hollow cylinders of 5 pounds (2265 gm) each with an outer radius of 2.5 inches (6.35 cm) and an inner radius of 2.3 inches (5.8 cm). The total inertia would be determined by:

calculating inertia for a hollow cylinder pulley:

$$J_p = \frac{1}{2} \frac{W}{g} (R_o^2 + R_i^2) = \frac{1}{2} \frac{5}{386} (2.5^2 + 2.3^2) = 0.0747 \text{ lb-in-s}^2$$

$$\text{Metric} = \frac{1}{2} \frac{2265}{980} (6.35^2 + 5.8^2) = 85.39 \text{ gm-cm-s}^2$$

calculating load inertia:

$$J_1 = \frac{W R^2}{g} = \frac{10 (2.5)^2}{386} = 0.1619 \text{ lb-in-s}^2$$

$$\text{Metric} = \frac{4530 (6.35)^2}{980} = 186.3 \text{ gm-cm-s}^2$$

the total inertia reflected to the motor shaft would be the sum of the above:

$$J = J_1 + J_{p1} + J_{p2} = 0.1619 + 0.0747 + 0.0747 = 0.3113 \text{ lb-in-s}^2$$

$$\text{Metric} = 357 \text{ gm-cm-s}^2$$

Don't forget to include the inertia of the pulleys, sprockets, or pinion gears in the determination of total inertia.

AC servo motors

Ballscrew drive

5

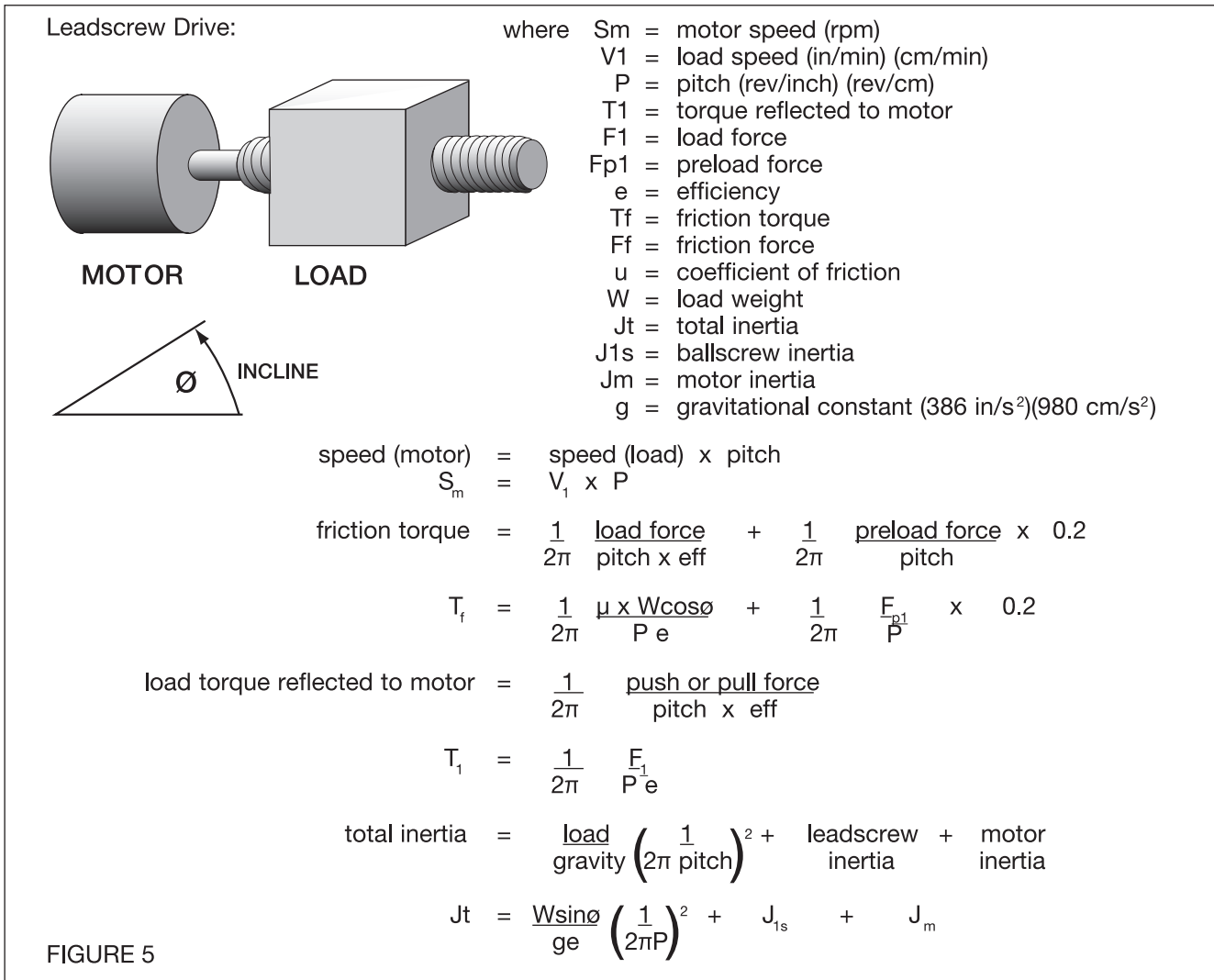

The load parameters have to be reflected back to the motor shaft for this type of drive as well. The inertias which have to be considered include the ballscrew as well as the load. If the ballscrew inertia is not readily available, the formula for a cylinder may be used. Figure 5 presents the formulas for determining reflected inertias.

As an example, a 200 lb (90.6 Kg) load will be positioned via a ballscrew which is 0.5 inch (1.27 cm) in radius and 44 inches (111.7 cm) long. The pitch is 5 rev/inch (1.96 rev/cm). The total load and ballscrew inertia would be:

calculating reflected load inertia:

$$J_1 = \frac{W}{g} \left(\frac{1}{2\pi P} \right)^2 = \frac{200}{386} \left(\frac{1}{2\pi 5} \right)^2 = 0.00052 \text{ lb-in-s}^2$$

$$\text{Metric} = \frac{90600}{980} \left(\frac{1}{2\pi 1.96} \right)^2 = 0.61 \text{ gm-cm-s}^2$$

calculating ballscrew inertia:

$$J_{1s} = \frac{1}{2} \frac{\pi L P R^4}{g} = \frac{1}{2} \frac{\pi (44) (.28) (5)^4}{386} = 0.00313 \text{ lb-in-s}^2$$

$$\text{Metric} = \frac{1}{2} \frac{(111.7)(7.75)(1.27)^4}{980} = 3.6 \text{ gm-cm-s}^2$$

The total inertia which would be connected onto the motor shaft would be the sum of these:

$$J = J_1 + J_{1s} = 0.00052 + 0.00313 = 0.00365 \text{ lb-in-s}^2 \text{ (Metric} = 4.21 \text{ gm-cm-s}^2)$$

For precision positioning applications, the ballscrew is sometimes preloaded to eliminate or reduce backlash. If preloading is used, the preload torque must be included since it can be significant. The ballscrew's efficiency must also be considered when finally determining torques.

AC servo motors

The move profile

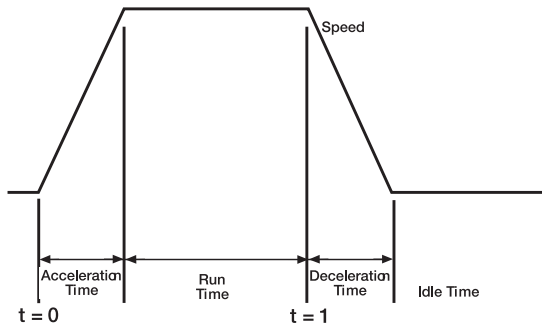

Figure 6

A move profile defines the desired acceleration rate, run time, speed and acceleration rate of the load. For example, suppose with a system at rest (time = 0 in Figure 6), the positioning controller issues a command to the motor to start motion. At t = 0, with full power applied, the motor has not yet started to move. At this instant, there is no feedback signal, but the error signal is large.

As friction and inertia torques are overcome, the motor and load begin to accelerate. As the motor reaches the commanded speed, the error signal is reduced, and in turn the voltage applied onto the motor is reduced. As the system stabilizes at running speed only nominal power (voltage and current) are required (to overcome friction). At time t = 1, the load approaches the desired position and begins to decelerate.

Applications with these move profiles result in most of the input energy dissipated as heat. Such packages are therefore limited by the maximum power dissipation capacity of the motor. In order to guarantee that maximum power handling capability of the motor is not exceeded, each application must be investigated individually. Basic motor dynamic equations must be solved and power calculated for each motor in order to determine whether the application will be handled successfully.

The first step in the process is identifying the acceleration rate. For an example, let's assume that our application has a move profile as identified in Figure 7. The acceleration rate can be determined from the speed and the acceleration time, as follows:

Example

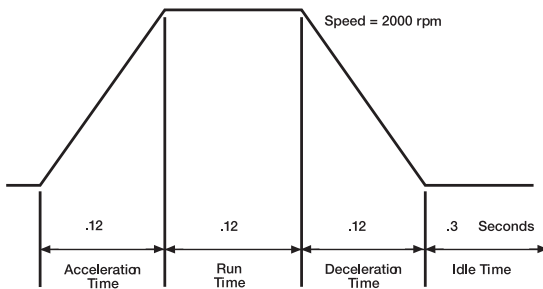

Figure 7

$$\text{accel rate} = \text{speed} \div \text{accel time}$$

$$\text{accel rate (rad/sec}^2\text{)} = \frac{Wm \text{ (rad/sec)}}{t_{\text{acc}} \text{ (sec)}}$$

To convert from RPM to rad/sec divide by 9.55.

For our example the acceleration rate is:

$$\text{accel rate (rad/sec}^2\text{)} = \frac{209 \text{ (rad/sec)}}{.12 \text{ (sec)}} = 1741.6 \text{ rad/sec}^2$$

Example parameters

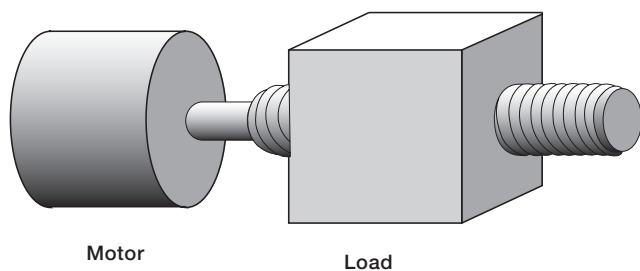

Figure 8

Motor parameters

- Inertia = .0037 lb-in-s² (4.26 gm-cm-s²)
- Continuous stall torque = 14.4 lb-in (1.6 Nm)
- Torque constant = 4.8 lb-in/amp (0.54 Nm/amp)
- Resistance = 4.5 ohms
- Thermal resistance = 1.56 °C/watt

Load conditions

- Load = 200 lbs (90.6 Kg)
- Ball screw inertia = .00313 lb-in-s² (0.61 gm-cm-s²)
- Friction torque = .95 lb-in (1094 gm-cm)

AC servo motors

Acceleration torque

The torque required to start the load moving, termed acceleration torque (T_{acc}), is that torque which is needed to overcome the mechanical friction and inertia. Expressed mathematically, the equation is:

$$T_{acc} = (J_t) (\text{accel rate}) + T_f$$

where T_{acc} is acceleration torque (lb-in)
 J_t is the total inertia (load and motor lb-in-s²)
 accel is rotary acceleration of the motor shaft (rad/sec²)
 T_f is the total friction torque of the package (lb-in)

As an example, the application calls for moving a 200 lb (90.6 Kg) load thru a ballscrew (having an inertia of .00313 lb-in-s²), (3.6 gm-cm-s²) at an acceleration rate of 1741.6 rad/sec². Typical motor parameters which will be used in this analysis are indicated in Figure 8.

$$\begin{aligned} T_{acc} &= (J_t) (\text{accel rate}) + T_f \\ T_{acc} &= (J_l + J_{ls} + J_m) (\text{accel rate}) + T_f \\ T_{acc} &= (0.00052 + 0.00313 + 0.0037) (1741.6) + 0.95 \text{ Metric} = (0.61 + 3.6 + 4.26) 1741.6 + 1094 \\ &= 12.8 + 0.95 \qquad \qquad \qquad \text{Metric} = 14751 + 1094 \\ &= 13.75 \text{ lb-in} \qquad \qquad \qquad \text{Metric} = 15845 \text{ gm-cm} (=1.55 \text{ Nm}) \end{aligned}$$

The motor must be capable of providing torque to accelerate the entire mechanics of the load (friction plus inertia), as well as torque to move itself. In this example, the motor must be capable of supplying a total acceleration torque of 13.75 lb-in (15.8 kg-cm).

Torque over the duty cycle

The motor must also be capable of providing a certain amount of torque continuously over the duty cycle, or move profile as was defined earlier. In order to determine this, we must look at the rest of the move profile and determine the torques associated with them.

During run time, the torque required is:

$$\begin{aligned} T_{run} &= T_f \\ T_{run} &= 0.95 \text{ lb-in} \qquad \qquad \qquad \text{Metric} = (1094 \text{ gm-cm}) \end{aligned}$$

During the stopping cycle, or deceleration, the torque required is:

$$\begin{aligned} T_{dec} &= - (J_t) (\text{accel rate}) + T_f \\ T_{dec} &= - (.00052 + .00313 + .0037) (1741.6) + .95 \qquad \qquad \qquad \text{Metric} = - (0.61 + 3.6 + 4.26)(1741.6) + 1094 \\ T_{dec} &= - 12.8 + .95 \qquad \qquad \qquad \text{Metric} = - 14751 + 1094 \\ T_{dec} &= - 11.85 \text{ lb-in} \qquad \qquad \qquad \text{Metric} = - 13657 \text{ gm-cm} \end{aligned}$$

Now that these torques are identified, the amount of torque required over the move profile can be calculated. This is termed "determining the RMS torque". It is calculated by simply inserting the figures from the previous page in to the following equation:

$$\begin{aligned} T_{RMS}^2 &= \frac{(T_{acc}^2 \times t_{acc}) + (T_{run}^2 \times t_{run}) + (T_{dec}^2 \times t_{dec})}{t_{acc} + t_{run} + t_{dec} + t_{idle}} \\ T_{RMS}^2 &= \frac{(13.75)^2 \times 0.12 + (0.95)^2 \times 0.12 + (11.85)^2 \times 0.12}{0.12 + 0.12 + 0.12 + 0.3} \text{ Metric} = \frac{(15.8)^2 \times 0.12 + (1)^2 \times 0.12 + (13.6)^2 \times 0.12}{0.12 + 0.12 + 0.12 + 0.3} \\ T_{RMS}^2 &= \frac{22.6 + 0.108 + 16.8}{0.66} = 59.86 \qquad \qquad \qquad \text{Metric} = \frac{29.9 + 0.12 + 22.1}{0.66} = 78.9 \text{ kg-cm} \\ T_{RMS} &= 7.73 \text{ lb-in} \qquad \qquad \qquad \text{Metric} = 8.8 \text{ Kg-cm} (= 0.86 \text{ Nm}) \end{aligned}$$

Thus, this application requires 7.73 lb-in (0.86 Nm) of torque. The motor for this example has the capability of providing a continuous torque of 14 lb-in (1.6 Nm).

AC servo motors

Control section

The next step is to determine requirements for a suitable control or drive (amplifier). The control must be able to supply sufficient acceleration current (for the application's acceleration requirements), as well as continuous current (or "RMS" current for the application's duty cycle requirements).

Acceleration current which must be supplied to the motor is calculated from:

$$\text{current (amps), acceleration} = \frac{\text{acceleration torque (lb-in)}}{\text{motor torque constant (lb-in/amp)}}$$

$$I_{\text{acc}} = \frac{T_{\text{acc}}}{K_{\text{tHOT}}}$$

Where $K_{\text{tHOT}} = K_{\text{tCOLD}} \times 0.9$ (Typical derate for Neodymium magnets).

$$= \frac{13.75 \text{ (lb-in)}}{4.8 \text{ (lb-in/amp)} \times 0.9} = 3.18 \text{ amps} \quad \text{Metric} = \frac{1.55 \text{ Nm}}{0.54 \text{ Nm/a} \times 0.9} = 3.18 \text{ amp}$$

RMS current over the duty cycle, which the control must be capable of supplying to the motor, is calculated from:

$$\text{current, RMS (amps)} = \frac{\text{RMS torque (lb-in)}}{\text{motor torque constant (lb-in/amp)}}$$

$$I_{\text{RMS}} = \frac{T_{\text{RMS}}}{K_{\text{t}}}$$

$$= \frac{7.73 \text{ (lb-in)}}{4.8 \text{ (lb-in/amp)} \times 0.9} = 1.78 \text{ amps} \quad \text{Metric} = \frac{0.86 \text{ Nm}}{0.54 \text{ Nm/a} \times 0.9} = 1.78 \text{ amp}$$

Thus the servo control which would be selected must have the capability of supplying currents of 3.18 amps for acceleration and 1.78 amps continuously (RMS over the duty cycle).

Temperature approximation

The temperature of the internal motor winding, or how hot a motor gets, depends upon the power dissipated inside the motor, and the motor's ability to eliminate itself of that heat. A measure of the motor's capability to eliminate heat is expressed as the thermal resistance.

The first step in determining the motor's winding temperature is to calculate power dissipation (watts dissipated). Using the previous determination of the applications current over the duty cycle, or I_{RMS} , of 1.78 amps, and the motor's resistance:

$$P_{\text{DISS}} = I^2 \times R_{\text{HOT}}$$

Where $R_{\text{HOT}} = R_{\text{COLD}} \times 1.5$

$$P_{\text{DISS}} = (1.78)^2 \times 4.5 \times 1.5 = 21.3 \text{ watts}$$

Then multiply times the motor's thermal resistance (deg C/watt) to obtain the winding temperature rise:

$$\text{Temperature Rise} = P_{\text{DISS}} \times R_{\text{th}} = 21.3 \times 1.56 = 33.3 \text{ deg C rise}$$

Thus total temperature rise in a 25 deg C ambient would be:

$$\text{Total temperature} = \text{ambient temp} + \text{temp rise} = 25 + 33.3 = 58.3 \text{ deg C}$$

Total temperature in a 40 deg C ambient would be:

$$\text{Total temperature} = 40 + 33.3 = 73.3 \text{ deg C}$$

Since the motor is designed to handle a total temperature of 155 deg C, both would be within the capability of the motor design. This easy calculation works well for speeds below 4000 rpm. At high speeds other dissipation issues such as friction and damping must be considered. If the 155 deg C temperature is exceeded, a larger motor should be investigated for the application.

AC servo motors

Temperature rise

The basic equation that determines temperature rise is:

$$T = T_{AMB} + (P_{Diss} \times R_{th})(1 - e^{-t/t_{TH}})$$

Where t = the motors' "on" or operating time, an t_{TH} = motors' thermal time constant - which is a measure of how long it takes to reach 63.2% of the final or steady state temperature.

The exponential rise of temperature versus time can easily be plotted by using the following points:

$$1/2 t_{TH} = 48\%, t_{TH} = 63.2\%, 3x t_{TH} = 95\%, 5x t_{TH} = 98\%, 7x t_{TH} = 99.99\%$$

This final point ($7x t_{TH}$) is the steady state temperature as calculated in the previous section. These points are shown on the curve in figure 9.

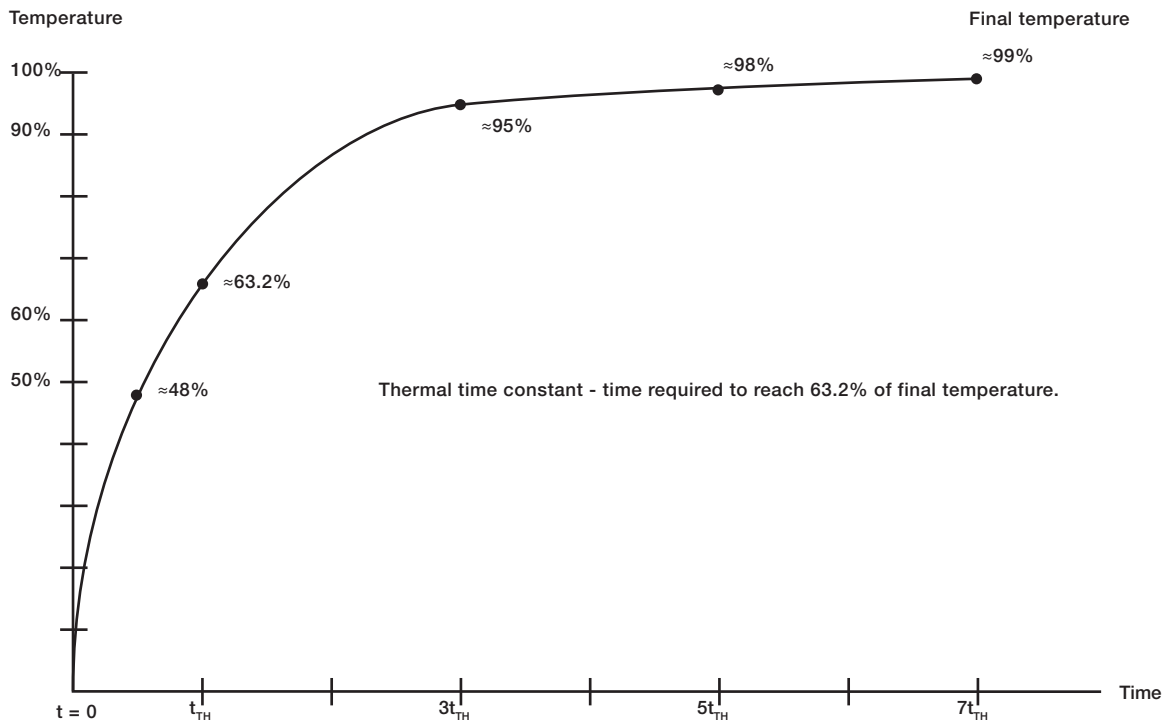

Figure 9 – Temperature Rise vs. Time

As an example, take the motor that has $P_{Diss} \times R_{th} = 92^{\circ}\text{C}$ with ambient of 40°C , then temperature rise is shown below, and to determine total temperature, the ambient of 40°C must be added to these figures.

Time	$\Delta\text{Temp rise}$	+ Ambient	= Total temp.
Thus: 1/2 t _{TH}	48% x 92 = 44.1	+ 40	= 84.1
t _{TH}	63.2% x 92 = 58.1	+ 40	= 98.1
3 t _{TH}	95% x 92 = 87.4	+ 40	= 127.4
5 t _{TH}	98% x 92 = 90.1	+ 40	= 130.1
7 t _{TH}	99.9% x 92 = 92.9	+ 40	= 132.9

With power applied, the motor winding heats up, attaining 63.2% of final temperature in one thermal time constant, and essentially reaches final temperature in 7 time constants.

AC servo motors

Servo motor requirement sheet

Company _____ Date _____

Contact _____ E-Mail _____

Title _____ Phone _____

Address _____ Fax _____

Address _____ Industry _____

City _____ State, Zip _____

Describe the application and what you are trying to accomplish:

Velocity profile

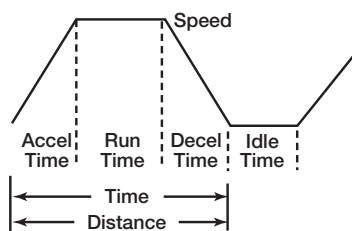

Specify

Speed = _____ RPM or in/sec or cm/sec
 Accel time = _____ sec
 Run time = _____ sec
 Decel time = _____ sec
 idle time = _____ sec

or:

Distance = _____ radians; or _____ inch or cm
 Time (total) = _____ sec
 Idle time = _____ sec

Load conditions

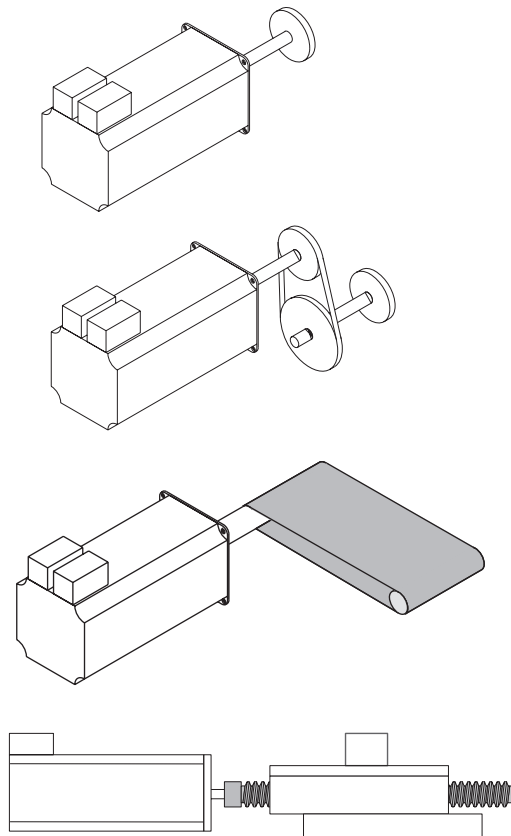

Direct drive

(Circle units)

Load inertia = _____ lb-in-s² (kg-cm²)(kg-cm-s²)
 Load friction = _____ lb-in (g-cm)

Reduction – belt or gearing

(Circle units)

Load inertia = _____ lb-in-s² (kg-cm²)(kg-cm-s²)
 or diameter = _____ inch (mm)
 and length = _____ inch (mm)
 Load friction = _____ lb-in (g-cm)
 Belt/gear ratio = _____ :1
 Efficiency = _____ %

Linear – belt pulley or rack & pinion

(Circle units)

Load weight = _____ lbs (kg)
 Belt/rack weight = _____ lbs (kg)
 Pulley radius = _____ inch (mm)
 Pulley inertias = _____ lb-in-s² (kg-cm²)(kg-cm-s²)
 Total friction = _____ lb-in (g-cm)
 Gear ratio = _____ :1
 Efficiency = _____ %

Linear – ball screw

(Circle units)

Load weight = _____ lbs (kg)
 load friction = _____ lb-in (g-cm)
 Screw pitch = _____ rev/inch (mm/rev)
 Screw inertia = _____ lb-in-s² (kg-cm²)(kg-cm-s²)
 or Diameter = _____ inch (mm)
 and Length = _____ inch (mm)
 Efficiency = _____ %

AC servo motors

Conversion tables

Rotary Inertia (to convert from A to B, multiply by value in table)

A \ B	gm-cm ²	oz-in ²	gm-cm-s ²	kg-cm ²	lb-in ²	oz-in-s ²	lb-ft ²	kg-cm-s ²	lb-in-s ²	lb-ft-s ² or slug-ft ²
gm-cm ²	1	5.46 x 10 ⁻³	1.01 x 10 ⁻³	10 ⁻³	3.417 x 10 ⁻⁴	1.41 x 10 ⁻⁵	2.37 x 10 ⁻⁶	1.01 x 10 ⁻⁶	8.85 x 10 ⁻⁷	7.37 x 10 ⁻⁸
oz-in ²	182.9	1	0.186	0.182	0.0625	2.59 x 10 ⁻³	4.34 x 10 ⁻⁴	1.86 x 10 ⁻⁴	1.61 x 10 ⁻⁴	1.34 x 10 ⁻⁵
gm-cm-s ²	980.6	5.36	1	0.9806	0.335	1.38 x 10 ⁻²	2.32 x 10 ⁻³	10 ⁻³	8.67 x 10 ⁻⁴	7.23 x 10 ⁻⁵
kg-cm ²	1000	5.46	1.019	1	0.3417	1.41 x 10 ⁻²	2.37 x 10 ⁻³	1.019 x 10 ⁻³	8.85 x 10 ⁻⁴	7.37 x 10 ⁻⁵
lb-in ²	2.92 x 10 ³	16	2.984	2.926	1	4.14 x 10 ⁻²	6.94 x 10 ⁻³	2.98 x 10 ⁻³	2.59 x 10 ⁻³	2.15 x 10 ⁻⁴
oz-in-s ²	7.06 x 10 ⁴	386.08	72	70.615	24.13	1	0.1675	7.20 x 10 ⁻²	6.25 x 10 ⁻²	5.20 x 10 ⁻³
lb-ft ²	4.21 x 10 ⁵	2304	429.71	421.40	144	5.967	1	0.4297	0.3729	3.10 x 10 ⁻²
kg-cm-s ²	9.8 x 10 ⁵	5.36 x 10 ³	1000	980.66	335.1	13.887	2.327	1	0.8679	7.23 x 10 ⁻²
lb-in-s ²	1.129 x 10 ⁶	6.177 x 10 ³	1.152 x 10 ³	1.129 x 10 ³	386.08	16	2.681	1.152	1	8.33 x 10 ⁻²
lb-ft-s ² or slug-ft ²	1.355 x 10 ⁷	7.41 x 10 ⁴	1.38 x 10 ⁴	1.35 x 10 ⁴	4.63 x 10 ³	192	32.17	13.825	12	1

5

Torque (to convert from A to B, multiply by value in table)

A \ B	dyne-cm	gm-cm	oz-in	kg-cm	lb-in	Nm	lb-ft	kg-cm
dyne-cm	1	1.019 x 10 ⁻³	1.416 x 10 ⁻⁵	1.0197 x 10 ⁻⁶	8.850 x 10 ⁻⁷	10 ⁻⁷	7.375 x 10 ⁻⁸	1.019 x 10 ⁻⁸
gm-cm	980.65	1	1.388 x 10 ⁻²	10 ⁻³	8.679 x 10 ⁻⁴	9.806 x 10 ⁻⁵	7.233 x 10 ⁻⁵	10 ⁻⁵
oz-in	7.061 x 10 ⁴	72.007	1	7.200 x 10 ⁻²	6.25 x 10 ⁻²	7.061 x 10 ⁻³	5.208 x 10 ⁻³	7.200 x 10 ⁻⁴
kg-cm	9.806 x 10 ⁵	1000	13.877	1	0.8679	9.806 x 10 ⁻²	7.233 x 10 ⁻²	10 ⁻²
lb-in	1.129 x 10 ⁶	1.152 x 10 ³	16	1.152	1	0.112	8.333 x 10 ⁻²	1.152 x 10 ⁻²
Nm	107	1.019 x 10 ⁴	141.612	10.197	8.850	1	0.737	0.101
lb-ft	1.355 x 10 ⁷	1.382 x 10 ⁴	192	13.825	12	1.355	1	0.138
kg-m	9.806 x 10 ⁷	105	1.388 x 10 ³	100	86.796	9.806	7.233	1

Material densities

	Oz/in ³	lb/in ³	gm/cm ³
Aluminum	1.57	0.098	2.72
Brass	4.96	0.31	8.6
Bronze	4.72	0.295	8.17
Copper	5.15	0.322	8.91
Plastic	0.64	0.04	1.11
Steel	4.48	0.28	7.75

Mechanism efficiencies

Acme screw (bronze nut)	0.4
Acme screw (plastic nut)	0.5
Ball screw	0.9
Helical gear	0.7
Spur gear	0.6
Timing belt/pulley	0.9

Friction coefficients

(Sliding)	μ
Steel on steel	0.58
Steel on steel (greased)	0.15
Aluminum on steel	0.45
Copper on steel	0.36
Brass on steel	0.40
Plastic on steel	0.20
Linear bearings	0.001

Temperature

$$^{\circ}\text{F} = (1.8 \times ^{\circ}\text{C}) + 32$$

$$^{\circ}\text{C} = .555 (^{\circ}\text{F} - 32)$$

Gravity

(Acceleration constant)

$$g = 386 \text{ in/s}^2 = 32.2 \text{ ft/s}^2 = 9.8 \text{ m/s}^2$$

AC servo motors

Conversion tables

Length (to convert from A to B, multiply by value in table)

A \ B	Inch	Feet	Micro inch	Micron	Millimeter	Centimeter	Meter
Inch	1	8.33 x 10 ⁻²	1.0 x 10 ⁶	2.51 x 10 ⁴	25.4	2.54	2.54 x 10 ⁻²
Feet	12	1	1.2 x 10 ⁷	3.05 x 10 ⁵	305	30.5	0.305
Micro-Inch	1.0 x 10 ⁻⁶	1.2 x 10 ⁴	1	2.54 x 10 ⁻²	2.54 x 10 ⁻⁵	2.54 x 10 ⁻⁶	2.54 x 10 ⁻⁸
Micron	3.937 x 10 ⁻⁵	3.28 x 10 ⁻⁶	39.37	1	0.001	1.0 x 10 ⁻⁴	1.0 x 10 ⁻⁶
Millimeter	3.937 x 10 ⁻²	3.28 x 10 ⁻³	3.937 x 10 ⁴	1000	1	0.1	0.001
Centimeter	0.3937	3.28 x 10 ⁻²	3.937 x 10 ⁵	1 x 10 ⁴	10	1	0.01
Meter	39.37	3.28	3.937 x 10 ⁷	1 x 10 ⁶	1000	100	1

Power (to convert from A to B, multiply by value in table)

A \ B	Watts	Kilowatts	ft-lb/sec	in-lb/sec	Hp (imperial)	Hp (SI)
Watts	1	1 x 10 ⁻³	0.74	8.85	1.34 x 10 ⁻³	1.33 x 10 ⁻³
Kilowatts	1000	1	738	8850	1.34	1.33
ft-lb/sec	1.35	1.36 x 10 ⁻³	1	12	1.82 x 10 ⁻³	1.81 x 10 ⁻³
in-lb/sec	0.113	1.13 x 10 ⁻⁴	8.3 x 10 ⁻²	1	1.52 x 10 ⁻⁴	1.53 x 10 ⁻⁴
Hp (Imperial)	746	0.746	550	6600	1	0.995
Hp (SI)	750	0.750	553	6636	1.005	1

Mass (to convert from A to B, multiply by value in table)

A \ B	oz-m	lb-m	slug	gm	kg
oz-m	1	6.25 x 10 ⁻²	1.94 x 10 ⁻³	28.35	2.835 x 10 ⁻²
lb-m	16	1	3.11 x 10 ⁻²	453.6	0.453
slug	514.72	32.2	1	14590	14.59
gm	3.53 x 10 ⁻²	2.205 x 10 ⁻³	6.85 x 10 ⁻⁵	1	0.001
kg	35.274	2.205	6.85 x 10 ⁻²	1000	1

Force (to convert from A to B, multiply by value in table)

A \ B	oz-f	lb-f	Newtons	dyne	gm-f	kg-f
oz-f	1	6.25 x 10 ⁻²	0.278	2.78 x 10 ⁴	28.35	2.835 x 10 ⁻²
lb-f	16	1	4.448	4.448 x 10 ⁵	453.6	0.4535
Newtons	3.596	0.225	1	1 x 10 ⁵	101.9	0.1019
dyne	3.59 x 10 ⁻⁵	2.248 x 10 ⁻⁶	1.0 x 10 ⁻⁵	1	1.02 x 10 ⁻³	1.02 x 10 ⁻⁶
gm-f	3.53 x 10 ⁻²	2.205 x 10 ⁻³	9.81 x 10 ⁻³	981	1	0.001
kg-f	35.3	2.205	9.81	9.81 x 10 ⁵	1000	1

Linear velocity (to convert from A to B, multiply by value in table)

A \ B	in/sec	feet/sec	mm/sec	cm/sec	meter/sec	inch/min	feet/min	meter/min	km/hour	miles/hour
in/sec	1	0.083	25.4	2.54	2.54 x 10 ⁻²	60	5	1.524	0.091	5.7 x 10 ⁻²
feet/sec	12	1	304.8	30.48	0.3048	720	60	18.29	1.09	0.682
mm/sec	3.937 x 10 ⁻²	3.3 x 10 ⁻³	1	0.1	0.001	2.36	0.197	0.059	3.6 x 10 ⁻³	2.24 x 10 ⁻³
cm/sec	0.3937	3.28 x 10 ⁻²	10	1	0.01	23.62	1.97	0.59	3.6 x 10 ⁻²	2.24 x 10 ⁻²
meter/sec	39.37	3.281	1000	100	1	2362.2	197	60	3.6	2.24
inch/min	0.0167	1.39 x 10 ⁻³	0.42	0.042	4.2 x 10 ⁻⁴	1	8.33 x 10 ⁻²	2.54 x 10 ⁻²	1.52 x 10 ⁻³	9.5 x 10 ⁻⁴
feet/min	0.2	0.0167	5.08	0.508	5.08 x 10 ⁻³	12	1	0.3048	1.8 x 10 ⁻²	1.14 x 10 ⁻²
meter/min	0.656	5.46 x 10 ⁻²	16.667	1.67	1.67 x 10 ⁻²	39.4	3.28	1	5.9 x 10 ⁻²	0.37
km/hour	10.936	0.911	277.8	27.78	0.2778	656	54.67	16.67	1	0.62
miles/hour	17.59	1.47	447	44.7	0.447	1056	88	26.8	1.609	1

MINT[®] motion control

Capability without complexity

ABB offers solutions to a variety of machine control applications in many industries. Our capability includes intelligent programmable drives, plug-in controller options for drives, real-time Ethernet controllers, PLC systems and standard analogue and stepper-based control products.

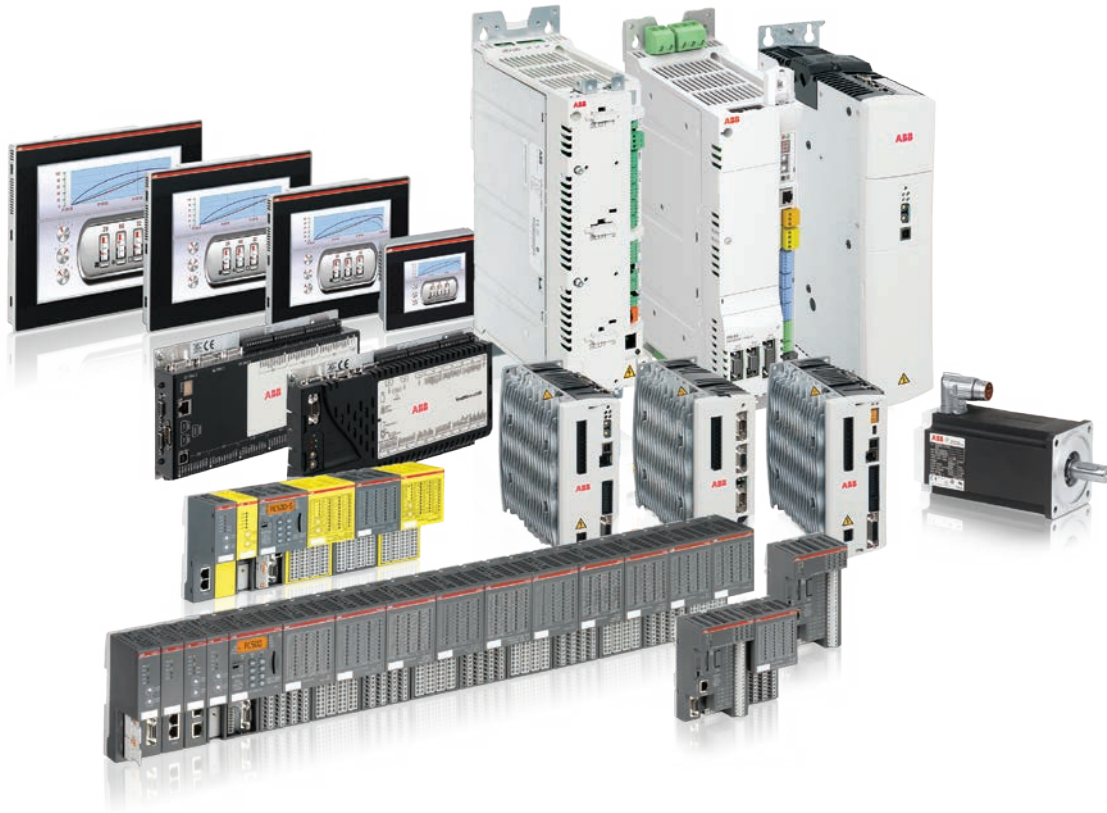

Motion controllers

MINT® programmable, analog, PTO, CANopen and POWERLINK

NextMove ESB-2

- Compact panel mount motion controller
- Up to 8 axes of coordinated motion
- Stepper and analog axis control
- CANopen manager for system expansion
- MINT programming for multitasking control of communications, logic, motion and HMI interaction in simple motion applications

NextMove e100

- Compact panel mount motion controller
- Ethernet PowerLink technology for real-time motion control
- Stepper and analog axis control
- CANopen manager for system expansion
- MINT programming for multitasking control of communications, logic, motion and HMI interaction in simple motion applications

6



Compact motion controller for analog and stepper control



Compact motion controller with real time Ethernet POWERLINK technology

Series NextMove ESB-2

- Up to 8 axes of coordinated motion
- 4 x PTO (Stepper) axes
- 3 or 4 x analog controlled axes with encoder feedback
- Maximum of 8 axes of control
- Digital and analog I/O including 4 x high speed registration latches
- Options
 - RS232 or RS422 serial option
 - Differential / single-ended stepper interfaces
 - 7 axis or 8 axis variants

Series NextMove e100

- 1 to 16 axes interpolated axes via POWERLINK
- Additional CN profiled POWERLINK axes
- 4 x PTO (stepper) axes
- 3 x analog controlled axes with encoder feedback
- Maximum of 30 axes of control
- Digital and analog I/O including 4 x high speed registration latches
- Options
 - Differential / single-ended stepper interfaces
 - 8, 12 or 16 axes of interpolated motion

Servo drives

Analog, PTO, POWERLINK and EtherCAT options

MicroFlex analog

- Compact motion control drive for single and three-phase operation
- +/- 10 V analog speed / torque demand or Pulse + Direction inputs
- Choice of resolver feedback or incremental encoder

MicroFlex e100

- Compact motion control drive for single and three-phase operation
- Ethernet PowerLink technology for real-time motion control
- MINT Lite programming for multitasking control of communications, logic, motion and HMI interaction in simple motion applications

6



Compact motion control drive for simple analog or PTO control



Compact motion control drive with real time Ethernet POWERLINK technology

Series MicroFlex analog

- 1 or 3-phase operation from 105 to 250 V AC
- 3, 6 and 9 A rms
- IP20 enclosure for cabinet installation (UL open)
- Auto-tuning and anti-resonance digital filters
- Suitable for single drive and multi-axis systems
- Controls rotary and linear AC servo motors
- Options
 - Space saving footprint EMC filter
 - Brake units

For further information, see flyer "ABB motion control drives, MicroFlex brushless AC servo drives", code: 3AUA0000123110 EN.

Series MicroFlex e100

- 1 or 3-phase operation from 105 to 250 V AC
- 3, 6 and 9 A rms
- IP20 enclosure for cabinet installation (UL open)
- Real-time Ethernet operation with PowerLink
- Suitable for single drive and multi-axis systems
- Controls rotary and linear AC servo motors
- Options
 - Space saving footprint EMC filter
 - Brake units

For further information, see flyer "ABB motion control products, MicroFlex e100 servo drives", code: 3AUA0000116018 EN.

MicroFlex e150

- Compact motion control drive with embedded safety for single and three-phase operation
- Ethernet technology including EtherCAT® for real-time motion control
- Advanced MINT programming for multitasking control of communications, logic, motion and HMI interaction in high performance motion applications



Intelligent motion control drive with embedded safety and EtherCAT® technology

MotiFlex e100

- Wide voltage range, DC bus capability and three-phase operation for a broad range of applications
- Ethernet PowerLink technology for real-time motion control
- MINT programming for multitasking control of communications, logic, motion and HMI interaction, plus a multi-axis plug-in motion option



Versatile motion control drive with integrated real-time Ethernet POWERLINK technology

Series MicroFlex e150

- 1 or 3-phase operation from 105 to 250 V AC
- 3, 6 and 9 A rms
- IP20 enclosure for cabinet installation (UL open)
- Embedded real-time Ethernet including EtherCAT®, Modbus TCP and Ethernet/IP™
- Suitable for single drive and multi-axis systems
- Controls rotary and linear AC servo motors
- Safe torque-off feature as standard
- Options
 - MINT Motion programming
 - Space-saving footprint EMC filter
 - Resolver adapter
 - Dual encoder splitter
 - Brake units

For further information, see flyer "ABB motion control products, MicroFlex e150 servo drives", code: 3AUJ0000097609 EN.

Series MotiFlex e100

- Three-phase operation from 180 to 528 V AC
- 1.5 to 65 A rms in three frame sizes
- IP20 enclosure for cabinet installation (UL open)
- Real time Ethernet operation with PowerLink
- Suitable for single drive and multi-axis systems
- Controls rotary and linear AC servo motors
- Integrated DC bus for energy sharing capability
- Options
 - Plug-in motion controller for up to five axes
 - Fieldbus options
 - Plug-in IO options (digital or analog)
 - Secondary feedback options, resolver or encoder
 - Filters, brake resistors, chokes and DC bus bars

For further information, see flyer "ABB motion control products, MotiFlex e100 servo drives", code: 3AUJ0000116019 EN.

AC motion control drives

EtherCAT® and POWERLINK options

MotiFlex e180

- EtherCAT®, Modbus/TCP, EtherNet/IP and POWERLINK
- DSL combined power and feedback option (December 2015)
- Advanced MINT programming for multi-tasking control of communications, logic, motion and HMI interaction in high performance motion applications
- Safety as standard



Versatile Motion
Control Drive with
integrated real-time
Ethernet technology

MotiFlex e180
(Size A)

Series MotiFlex e180

- Three-phase operation 200...480 V AC
- 2.3 to 90 A Arms in four frame sizes (A-D)
- IP20 enclosure for cabinet installation (UL Open)
- Real-time Ethernet with EtherCAT and PowerLink and Modbus TCP and EtherNet/IP
- Suitable for single drive and multi-axis systems
- Controls rotary and linear AC servo motors
- Safe torque off as standard
- Memory unit for firmware, settings and functionality level
- Options
 - Drive functionality levels (Single axis Mint motion) or EtherCAT Slave
 - Feedback options, resolver, encoder, serial encoders or DSL (December 2015)
 - Filters, brake resistors, and chokes

For further information, see flyer
“ABB motion control drives, MotiFlex e180 servo drives”,
code: 3AUA0000168682 EN.

AC motion control drives

MicroFlex® series



MicroFlex e150

MicroFlex e150 (EtherCAT, Ethernet/IP, Modbus TCP/IP, MINT programming)

- Compact EtherCAT motion control drive
- Simple to advanced motion technology fully integrated
- Powerful PC tool for commissioning and auto-tuning
- Precise control of rotary and linear motors
- Embedded EtherCAT®, Ethernet/IP™, Modbus TCP/IP
- Standard I/O: (10) inputs + (7) outputs
- Universal and Dual Encoder function
- Safe Torque Off (STO) SIL3 PLe
- USB, RS422 and RS485 serial
- 7 - segment display communications

Input voltage	1/3 phase 105-250 V AC	
Bus voltage	160-320 V DC	
Output current amps (rms)		Order code
Continuous rms	Peak (3 seconds)	
3	6	E152A03EIOA
6	12	E152A06EIOA
9	18	E152A09EIOA

Note: Will accept either incremental or absolute encoder feedback (BiSS, EnDat, SSI, SmartAbs®).
Dual encoder mode and resolver supported via option.

EtherCAT slave device drive (standard TCP/IP, non-programmable)

Input voltage	1/3 phase 105-250 V AC	
Bus voltage	160-320 V DC	
Output current amps (rms)		Catalog number
Continuous rms	Peak (3 seconds)	
3	6	E152A03EINA
6	12	E152A06EINA
9	18	E152A09EINA

MicroFlex e100 (Ethernet POWERLINK)

- Compact Ethernet Powerlink motion control drive
- Simple motion programming with MINT Lite software and auto-tuning
- Ethernet - Powerlink, Modbus TCP and TCP/IP
- Universal encoder
- CANopen port for simple expansion
- USB and RS485 serial communications
- LEDs: Drive status, CANopen, Ethernet Powerlink



MicroFlex e100

Input voltage	1/3 phase 105-250 V AC	
Bus voltage	160-320 V DC	
Output current amps (rms)		Oder code
Continuous rms	Peak (3 seconds)	
3	6	MFE230A003BW
6	12	MFE230A006BW
9	18	MFE230A009BW

Note: Will accept either incremental or absolute encoder feedback (BiSS, EnDat, SSI, SmartAbs®)

MicroFlex analog

- Compact analog motion control drive
- Encoder/resolver feedback and simulated encoder output
- RS232/422 serial communications for PC tools
- Analog or pulse and direction control



MicroFlex analog

Input voltage	1/3 phase 105-250 V AC		
Bus voltage	160-320 V DC		
Output current amps (rms)		Order code	
Continuous rms	Peak (3 seconds)	(RS232 versions)	Order code (RS485 versions)
Encoder feedback			
3	6	FMH2A03TR-EN23W	FMH2A03TR-EN43W
6	12	FMH2A06TR-EN23W	FMH2A06TR-EN43W
9	18	FMH2A09TR-EN23W	FMH2A09TR-EN43W
Resolver feedback			
3	6	FMH2A03TR-RN23W	FMH2A03TR-RN43W
6	12	FMH2A06TR-RN23W	FMH2A06TR-RN43W
9	18	FMH2A09TR-RN23W	FMH2A09TR-RN43W

AC motion control drives

MotiFlex® e100



MotiFlex e100 Size A
(1.5 A - 16 A)

MotiFlex e100

- Advanced servo drive/motion controller
- Simple motion programming with Mint Lite software, auto-tuning and plug-in motion controller option
- Universal and dual encoder function including optional resolver interface
- Ethernet Powerlink interface (real time) and CANopen DSP 401 network manager for expansion
- DC bus operation with simple link system
- 2 x expansion card slots for secondary feedback, Mint programmable options, fieldbus and I/O expansion

Input voltage		3 phase 180-560 V AC	
Bus voltage		325-650 V DC	
Output current amps (rms) rated operation 200% 3 seconds			
	Continuous	Peak	Order code
Size A	1.5	3	MFE460A001BW
	3	6	MFE460A003BW
	6	12	MFE460A006BW
	10.5	21	MFE460A010BW
	16	32	MFE460A016BW
Size B	21	40	MFE460A021BW
	26	54	MFE460A026BW
	33.5	68	MFE460A033BW
Size C	48	96	MFE460A048BW
	65	130	MFE460A065BW

Accessories for MotiFlex e100

Description	Order code
AC power and motor power brackets	OPT-CM-001
Signal and feedback cable bracket size A	OPT-CM-002
Signal and feedback cable bracket size B / C	OPT-CM-003
DC bus bars for A size drive x 2	OPT-MF-DC-A
DC bus bars for B size drive x 2	OPT-MF-DC-B
DC bus bars for C size drive - 160mm x 2	OPT-MF-DC-C
DC bus bars for C size drive - 212mm x 2	OPT-MF-DC-D
Spare connector kit for 1 - 16A	OPT-MF-CN-A
Spare connector kit for 21 - 33.5A	OPT-MF-CN-B
Spare connector kit for 48 - 65A	OPT-MF-CN-C
USB signal isolator	OPT-CNV-003



MotiFlex e100 Size B
(21 A - 33.5 A)

AC line reactors for use with MotiFlex e100

Control current rating	Order code
1 - 6 Size A	LRAC02502
10 - 16 Size A	LRAC03502
21 - 33.5 Size B	LRAC05502
48 - 65 Size C	LRAC130ACB2



MotiFlex e100 Size C
(48 A - 65 A)

Plug in option cards for use with MotiFlex e100

Description	Order code
Single axis MINT motion option (plug-in)	OPT-MF-100
Multi-axis MINT motion option (plug-in)	OPT-MF-101
Analog I/O 16 bit 4 off inputs and 4 off outputs differential +/-10 V DC	OPT-MF-001
Digital I/O card 6 off digital inputs (AC optos), 4 off digital output	OPT-MF-005
Incremental encoder + halls with simulated encoder out option	OPT-MF-011
Resolver with simulated encoder out option card	OPT-MF-013

Fieldbus options

Fieldbus carrier option (required for ALL fieldbus cards)	OPT-MF-030
DeviceNet fieldbus option	OPT-FB-001
Profibus fieldbus option	OPT-FB-002
Ethernet/IP fieldbus option	OPT-FB-004
Modbus TCP fieldbus option	OPT-FB-005
Profinet I/O fieldbus option	OPT-FB-006

AC motion control drives

MotiFlex® e180



Frame Size A



Frame Size B



Frame Size C



Frame Size D

MotiFlex e180

- Integrated EtherCAT, Modbus/TCP, TCP/IP, EtherNet/IP and EtherNet Powerlink (EPL)
- EtherCAT DS402 slave, analog drive, step and direction programming option
- Single-axis MINT programming option with advanced MINT programming for multi-tasking control of communications, logic, motion and HMI interaction in high-performance motion applications
- Safe Torque Off (STO) as standard
- Controls rotary and linear AC servo motors with up to 300% overload modes; induction motors up to 150%
- Removable memory unit for firmware, application programs, functionality level, fast service replacements and moving settings from one drive to another
- Dual encoder is supported (incremental encoder input and output), single or multi-turn absolute encoders and resolver interface
- Common DC bus operation
- Partnered with ABB's AC500 PLC line with EtherCAT real-time high-performance or Modbus TCP control for simple applications

Frame	Size	Ratings / 4 kHz								3 phase 200 - 480 V AC 270-650 V DC
		110% 60s		150% 60s		200% 3s		300% 3s		Partial Catalog Number 1 2
		I _{2N}	I _{2max}	I _{2N}	I _{2max}	I _{2N}	I _{2max}	I _{2N}	I _{2max}	
A	-03A0-4	3.0	3.3	3.0	4.5	3.0	6.0	2.0	6.0	MFE180-04AN-03A0-4
	-05A0-4	5.0	5.5	5.0	7.5	4.0	8.0	2.7	8.1	MFE180-04AN-05A0-4
	-07A0-4	6.4	7.1	6.0	9.0	4.7	9.4	3.2	9.6	MFE180-04AN-07A0-4
B	-016A-4	14.0	15.4	11.0	16.5	9.0	18.0	7.0	21.0	MFE180-04AN-016A-4
	-024A-4	21.5*	23.7*	17.0*	25.5*	13.5	27.0	10.0	30.0	MFE180-04AN-024A-4
C	-031A-4	28.0*	30.8*	25.0*	37.5*	21.0	42.0	16.0	48.0	MFE180-04AN-031A-4
	-046A-4	41.0*	45.1*	35.0*	52.5*	28.0	56.0	20.0	60.0	MFE180-04AN-046A-4
	-060A-4	62.0*	68.2*	46.0*	69.0*	35.0	70.0	25.0	75.0	MFE180-04AN-060A-4
D	-090A-4	90.0*	99.0*	70.0*	105.0*	55.0	110.0	40.0	120.0	MFE180-04AN-090A-4

Frame	Size	Ratings / 8 kHz								3 phase 200 - 480 V AC 270-650 V DC
		110% 60s		150% 60s		200% 3s		300% 3s		Partial Catalog Number 1 2
		I _{2N}	I _{2max}	I _{2N}	I _{2max}	I _{2N}	I _{2max}	I _{2N}	I _{2max}	
A	-03A0-4	3.0	3.3	3.0	4.5	2.3	4.6	1.6	4.8	MFE180-04AN-03A0-4
	-05A0-4	4.0	4.4	4.0	6.0	3.0	6.0	2.2	6.6	MFE180-04AN-05A0-4
	-07A0-4	5.0	5.5	4.0	6.0	4.0	8.0	3.0	9.0	MFE180-04AN-07A0-4
B	-016A-4	10.0	11.0	9.0	13.5	7.0	14.0	5.0	15.0	MFE180-04AN-016A-4
	-024A-4	17.5*	19.3*	15.0*	22.5*	12.0	24.0	9.0	27.0	MFE180-04AN-024A-4
C	-031A-4	25.0*	27.5*	20.0*	30.0*	18.0	36.0	13.0	39.0	MFE180-04AN-031A-4
	-046A-4	33.0*	36.3*	31.0*	46.5*	25.0	50.0	17.0	51.0	MFE180-04AN-046A-4
	-060A-4	45.0*	49.5*	35.0*	52.5*	28.0	56.0	21.0	63.0	MFE180-04AN-060A-4
D	-090A-4	55.0*	60.5*	47.5*	71.3*	40.0	80.0	30.0	90.0	MFE180-04AN-090A-4

NOTES:

For pricing included with "complete" catalog number, see MotiFlex e180 List Price page.

* To achieve listed 110% and 150% ratings, only Frames C and D models (-024A-4 to -090A-4) require a mains choke (AC or DC)

- 1) Add required feedback interface (+ plus code) to base drive part number
- 2) Add programming option (+ plus code) if applicable

MotiFlex e180 has four different overload modes as user selection: 110%, 150%, 200%, 300%

I_{2N} Maximum continuous rms current in selected overload mode. Load current duty cycle rms should be lower than this

I_{2max} Maximum overload rms current for 60s (110%, 150%) or 3s (200%, 300%) in selected overload mode

Some 4kHz or 8kHz selection guidelines include the following:

- 4kHz gives higher output currents
- Use 8kHz for applications requiring:
 - quieter operating environments
 - decreased motor losses with derated drives

110% / 150% ratings are similar to "Heavy Duty" mode matching the application and motor type.

200% / 300% ratings are similar to "Dynamic" mode matching the application and motor type.

Example 1:

- 6A RMS, 20A Peak (≤ 3s)
- The -016A-4 Frame B 4kHz 300% Drive is rated for 7A RMS, 21A Peak - exceeding requirements

Example 2:

- 5.6A RMS, 8.8A Peak (≤ 3s)
- The -07A0-4 Frame A 4kHz 150% Drive is rated for 6A RMS, 9A Peak - exceeding requirements

AC motion control drives

MotiFlex® e180



Frame Size A

Feedback interface to base drive

Description	Order plus code
FB-01: Incremental encoder + halls	+L517
FB-02: Digital encoder (serial interfaces), ±SinCos (1v pk-pk), EnDat, Smart Abs, SSI, BiSS, Hiperface	+L518
FB-03: Resolver	+L516

NOTE:

1) See Type Code List Price for complete catalog numbers.

For pricing included with "complete" catalog number, see MotiFlex e180 List Price page.

On all variants:

- Incremental encoder input
- Simulated encoder output

Programming option

Description	Order plus code
Standard firmware installed as default if no other option is selected (EtherCAT DS402 slave, analog drive, step and direction (12-24 Vdc) controlled Drive.	-
Single axis MINT programming	+N8020

NOTE:

1) See Type Code List Price for complete catalog numbers.

For pricing included with "complete" catalog number, see MotiFlex e180 List Price page.



Frame Size B



Frame Size C



Frame Size D

AC motion control drives

How to select a MotiFlex® e180 Drive

Type designation:

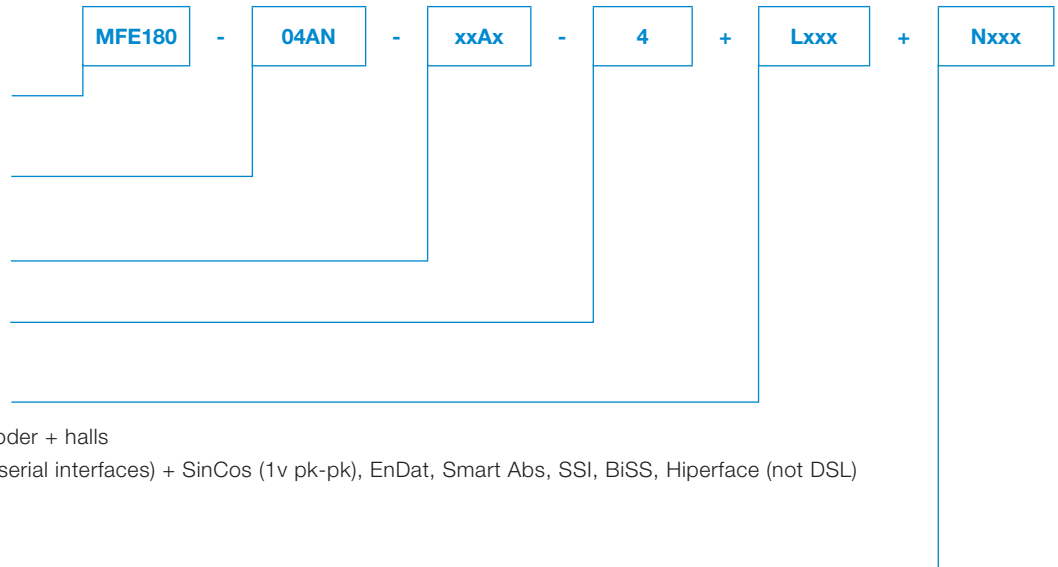

Product series

MotiFlex e180

Constructions

04AN: Air cooled module

Size

Voltage ratings

4 200 to 480 VAC +/- 10%

Feedback options

+L517 FB-01: Incremental encoder + halls

+L518 FB-02: Digital encoder (serial interfaces) + SinCos (1v pk-pk), EnDat, Smart Abs, SSI, BiSS, Hiperface (not DSL)

+L516 FB-03: Resolver

Functionality level options

+N8020 MINT single-axis programming

-- Standard firmware installed as default if no other option is selected (EtherCAT DS402 slave, analog Drive, step and direction (12-24 Vdc) controlled Drive)

Dimensions

Drive only

Frames	Height		Width		Depth		Weight	
	mm	in	mm	in	mm	in	kg	lb
A	364	14.3	90	3.54	144	5.67	3	6.61
B	380	15	100	3.94	221	8.7	5	11
C	467	18.4	165	6.5	223	8.78	10	22
D	467	18.4	220	8.66	223	8.78	17	37.5

NOTES:

Height is the maximum measure without clamping plates
In depth an additional 50 mm (2 in) should be reserved for feedback cabling

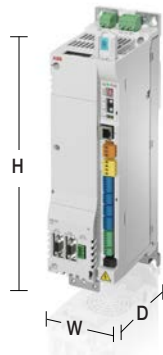

Accessory Brackets

Frames	Drive height w/ bracket	
	mm	in
A	474	18.66
B	476	18.74
C	558	21.96
D	644	25.35

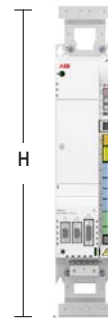

Technical data

Supply connection	
AC Supply	3-phase 200 to 480 V AC +/-10% 50/60 Hz +/-5%
DC supply	270 to 650 V DC +/-10%
Motor connection	
Voltage	3-phase output voltage
Frequency	0 to +/-500 Hz
Motor control	Torque, velocity, position, closed loop vector control, open loop V/Hz
Motor types	Asynchronous motors (standard induction, servo) and synchronous motors (servo, high torque), linear servo motors, linear induction motors
Switching frequency / Control	4 / 8 kHz; Space vector modulation
Braking power connection	
Braking chopper	As standard in all types
Braking resistor	External resistor connected to Drive
Product compliance	
CE	Low Voltage Directive 2006/95/EC, EN 61800-5-1: 2007 Machinery Directive 2006/42/EC, EN 61800-5-2: 2007 EMC Directive 2004/108/EC, EN 61800-3: 2004 + A1: 2012
C-Tick	Pending
UL	cUL/UL508C (2010) Power Conversion Equipment.
RoHs	RoHS directive 2011/65/EU
TUV	STO function

Environmental limits	
Ambient temperature	
Transport	-40 to +70°C (-40 to +158°F)
Storage	-40 to +70°C (-40 to +158°F)
Operation	0 to +55°C (32 to 131°F), no frost allowed.
Temperature	Above 40°C (104°F) with derating of 2%/1°C
Cooling method	
Air-cooled	Dry clean air
Altitude	0 to 2000 m (6560 ft) above sea level. Derating above 1000 m (3280 ft) 1%/100 m (328 ft)
Relative humidity	Max. 95%, no condensation allowed
Degree of protection	IP20 acc. to EN 60529; Open Type acc. to UL 508C
Contamination levels	No conductive dust allowed
Vibration	Sinusoidal vibration (EN 60068-2-6:2008): 2 to 9 Hz: 3.0 mm (0.12) 9 to 200 Hz: 1g
Shock	Half sine pulse (IEC 60068-2-27:2008): 10g for 11 ms
EMC	Category C3 with optional filter (according to EN 61800-3)
Functional safety	Safe torque off (STO according EN 61800-5-2) EN 61508 ed2: SIL 3, EN 62061: SIL CL 3, EN ISO 13849-1: PL e

Motion controllers

NextMove



NextMove e100

NextMove e100 (Ethernet Powerlink, Modbus® TCP and Modbus RTU)

- Compact, high performance motion controller
- Real-time Ethernet Powerlink and Modbus® TCP/IP
- 8, 12 or 16 axes of interpolated motion
- (16 MN + 14 CN) profiled axes = max. 30 Powerlink axes
- 4 stepper axes / 3 analog axes
- CANopen® network manager
- RS232/422 and USB communications
- Advanced multitasking MINT programming
- ActiveX® controls
- Integrated digital/analog I/O including high speed registration inputs.

Number of axes	Order code		Price
	Differential stepper	Single ended stepper	
8	NXE100-1608DBW	NXE100-1608SBW (1)	
12	NXE100-1612DBW	NXE100-1612SBW (1)	
16	NXE100-1616DBW	NXE100-1616SBW (1)	

(1) For use with DSMS stepper/driver.

6



NextMove ESB-2

NextMove ESB-2

- Compact, panel mount motion controller
- Economical and simple to install
- Powerful multitasking MINT programming
- 4 axes of closed loop control
- 4 axes of open loop control (step/direction outputs)
- Max. 8 axes
- USB, serial and CANopen® provide flexible communications to PLC, distributed I/O and other devices
- Integrated digital/analog I/O including high speed registration inputs
- Firmware variant allows the controller to operate as a CANopen® DS402 master and control up to 64 axes.

Number of axes	Serial port	Order code		Price
		Differential stepper	Single ended stepper	
7	RS232 / USB	NSB202-501W	NSB203-501W	
7	RS485 / USB	NSB202-502W	NSB203-502W	
8	RS232 / USB	NSB204-501W	NSB205-501W	
8	RS485 / USB	NSB204-502W	NSB205-502W	



NextMove PCI-2

NextMove PCI-2

- Compact, high performance PCI-bus motion controller
- 4 stepper axes + 4 analog axes = max. 8 axes
- Onboard digital and analog I/O
- CANopen® for distributed control
- High speed PCI bus interface
- Advanced multitasking MINT or ActiveX® programming
- Firmware variant allows the controller to operate as a CANopen® DS402 master and control up to 64 axes.

Number of axes	Order code		Price
	PNP outputs	NPN outputs	
1 (2)	PCI201-501	PCI201-511	
2 (2)	PCI201-502	PCI201-512	
3 (2)	PCI201-503	PCI201-513	
4 (2)	PCI201-504	PCI201-514	
8 (3)	PCI201-508	PCI201-518	

(2) User configurable for servo or stepper. (3) 4-axis servo control and 4-axis stepper.

Plug in option cards for use with MotiFlex e100

- Plug-in motion controller
- 4 POWERLINK axes + 1 analog axes = max. 5 axes
- Onboard digital and analog I/O
- Encoder input for electronic gearing functions
- CANopen® manager for I/O expansion (via host drive)
- Add CP600 HMI via RS485 Modbus® RTU
- Fully utilize drive I/O and interfaces including additional option cards.

Description	Order code	Price
Single axis MINT motion option (plug-in)	OPT-MF-100	
Multi-axis MINT motion option (plug-in)	OPT-MF-101	



MotiFlex e100 connection panel

ABB DriveSize and MCSize Software Tool

DriveSize is ABB's product selection software. The MCSize plug-in is specifically for the determination of servo motors and selected drives for motion control systems.

MC Size is available with a motor database, motor selection criteria and user selection information to make the process of choosing a servo motor and drive easier and more accurate.

Download DriveSize and MCSize from ABB's website:

<http://new.abb.com/drives/software-tools/drivesize>

NOTES:

- MCSize does not contain product price information, but attempts to ascertain a low-cost solution by offering lower current motors. It is necessary to check the cost of alternative solutions to determine the best offering for specific customer requirements.
- MCSize does not select the feedback type or other motor options. Please ensure you identify the required options, including the feedback type, and modify the specified part numbers accordingly.

DriveSize 4.0

New

- Industrial and machinery single drives**
Complete, well enclosed AC drives having a rich set of variants, options and programmability, with following constructions: wall-mounted, free standing, cabinet built, liquid cooled and modules. In most cases controlling one single induction or permanent magnet motor. Normal two quadrant drives are complemented with regenerative and low harmonic models;
- Industrial multidrives**
AC drives supplying multiple motors and controlled by multiple control units. Principle is based on common DC bus enabling single power entry with Diode, Thyristor or IGBT Supply unit and enabling multiple inverters from the same DC bus. Drive construction is air or liquid cooled. Multidrive module computing is supported too. The construction selection is done at supply level and inherited to inverters.
- General purpose drives**
Complete AC drives to control typically one single induction motor or multiple equal size motors having
- Drives for HVAC**
Complete AC drives to control typically a HVAC fan or pump motor or multiple equal size motors. Drives

System configuration

- [transformer]
- [drive]
- [motor]
- [gearing]
- Conveyor

Motion

- Duty type: Simple cyclic
- Profile type: Trapezoidal 1/3,1/3,1/3
- Accel/ Decel type: Linear
- Movement distance [m]: 10 [Change type](#)
- Movement time [s]: 5
- Dwell time [s]: 0

Mechanics

- Type: Conveyor
- Load mass [kg]: 10
- Belt mass [kg]: 5
- Driver roller: 0.2
- Driven roller: 0.2
- Idler roller: 0.0
- Coupling inertia [kgm²]: 0
- Efficiency [%]: 95
- Incline angle [deg]: 0
- Coefficient of friction: 0.001
- Opposing force [N]: 0

Motion results

- Acceleration time [s]: 1.667
- Deceleration time [s]: 1.667
- Acceleration [m/s²]: 1.8
- Deceleration [m/s²]: 1.8
- Max velocity [m/s]: 3

Mechanical results

- Opposing torque [Nm]: 0.015
- Equivalent inertia [kgm²]: 0.150

Combined results

- Max torque [Nm]: 2.858
- Max speed [rpm]: 286.479
- Max power [kW]: 0.086

Graph type: Speed vs. time

Speed [m/s] vs. Time [s]

Time [s]	Speed [m/s]
0	0
1	1.5
2	3
3	3
4	1.5
5	0

PLC AC500

AC500 system overview

AC500, superior local extension capabilities for I/O communication and best-in-class CPU functionality and industry leading performance.

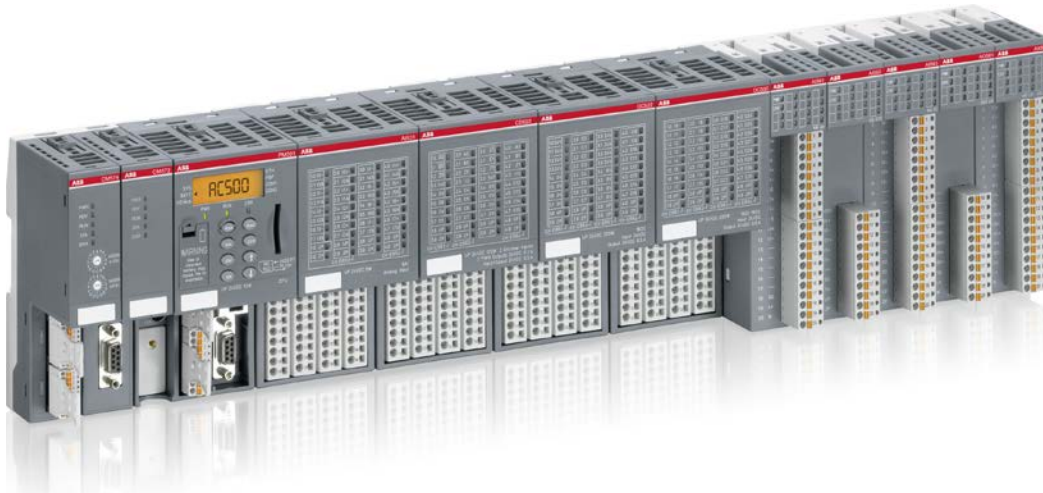

1 AC500 CPUs can be locally expanded with up to 10 I/O modules (Standard S500 and S500-eCo I/O modules can be mixed).

6



2 Terminal base



3 Communication module
Up to 4 modules in numerous combinations to communicate with nearly everything



4 CPU module



5 S500 Terminal unit



6 S500 I/O module



7 S500-eCo I/O module

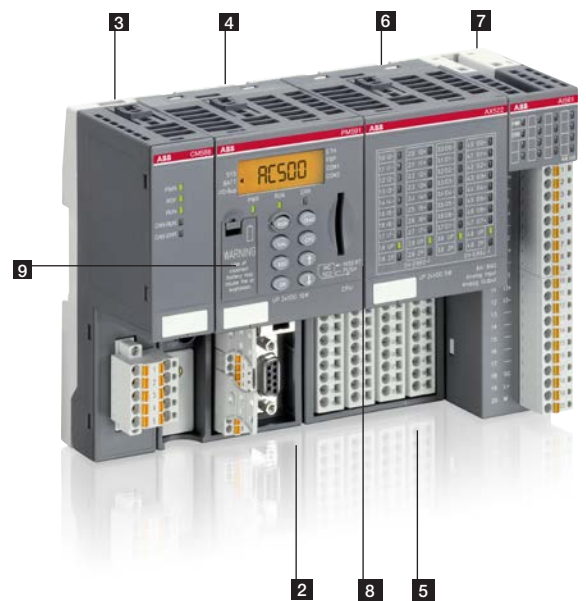

8 SD-card



9 Battery

MCSIZE

PLC AC500

AC500-eCo system overview

AC500-eCo CPUs can be locally expanded with up to 10 I/O modules.
 New AC500-eCo CPUs for use with pluggable terminal blocks available.

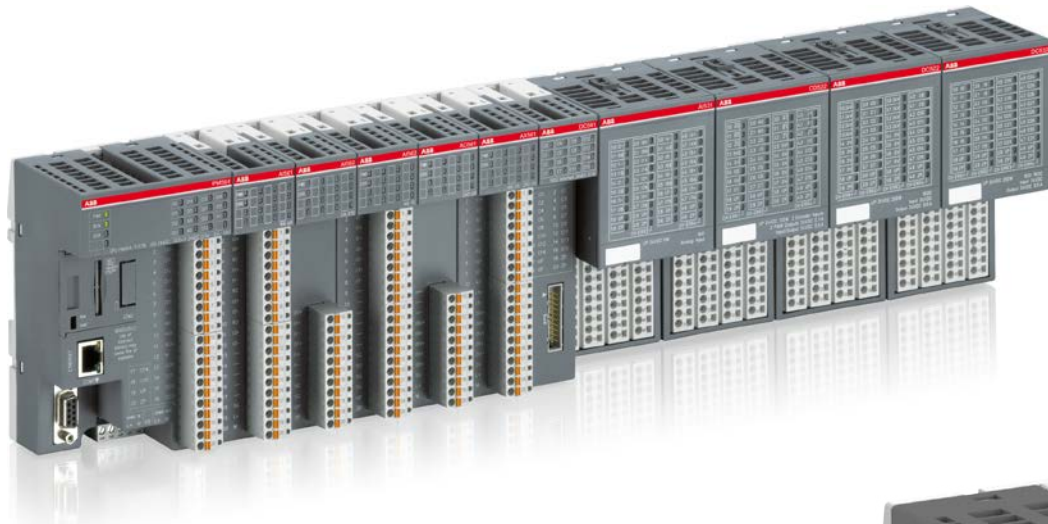

1 AC500-eCo CPUs can be locally expanded with up to 10 I/O modules (Standard S500 and S500-eCo I/O modules can be mixed).

AC500-eCo Starter Kits Available!

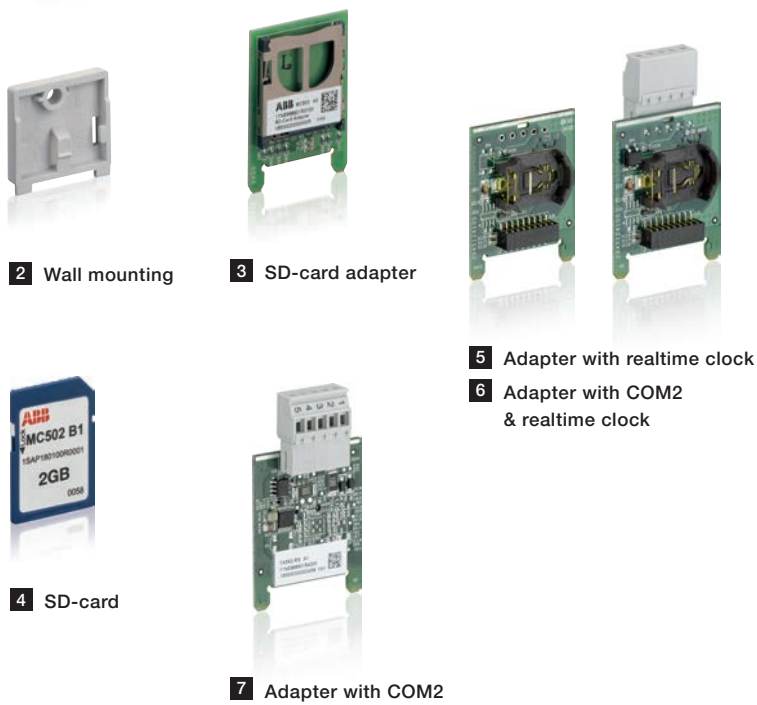

2 Wall mounting

3 SD-card adapter

4 SD-card

5 Adapter with realtime clock

6 Adapter with COM2 & realtime clock

7 Adapter with COM2



8 Terminal blocks



9 RS485 isolator for COM1



10 COM1 USB

11 COM2 USB programming cable

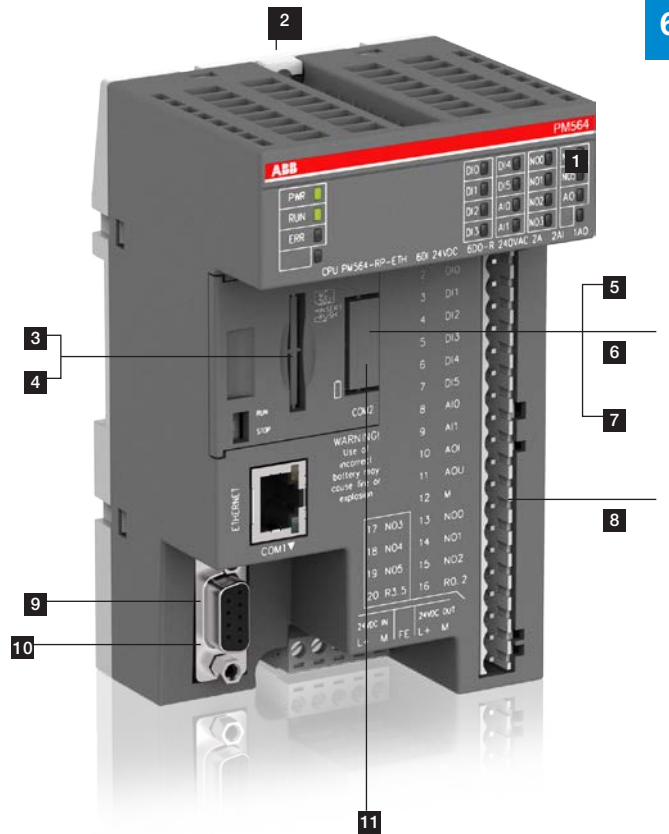

6

PLC AC500

PLC AC500-XC for extreme conditions; ruggedized variants when interacting with the elements in wind, solar, water, cranes, robotics, marine, and other harsh environment applications



6



Operating in wet environments

- Increased resistance to 100% humidity with condensation.



Extended operating temperature

- 40°C up to +70°C operating temperature



Use at high altitudes

- Operating altitude up to 4,000 m above sea level



Extended immunity to hazardous gases and salt mist

- G3, 3C2 immunity
- Salt mist EN 60068-2-52 / EN 60068-2-1



Extended immunity to vibration

- 4 g root mean square random vibration up to 500 Hz
- 2 g sinusoidal vibration up to 500 Hz



Extended EMC requirements

- EN 61000-4-5 surge immunity test
- EN 61000-4-4 transient / burst immunity test

For your notes

A series of horizontal dotted lines for taking notes.

For your notes

Dotted lines for notes

For your notes

A series of horizontal dotted lines for taking notes.

Contact us

You can find the address of your local sales organization on the ABB homepage:

www.abb.com/motion

Note: We reserve the right to make technical changes or modify the contents of this document without prior notice. With regard to purchase orders, the agreed particulars shall prevail. ABB Ltd does not accept any responsibility whatsoever for potential errors or possible lack of information in this document.

We reserve all rights in this document and in the subject matter and illustrations contained therein. Any reproduction, disclosure to third parties or utilization of its contents – in whole or in part – is forbidden without prior written consent of ABB Ltd.

Copyright © 2015 ABB

All rights reserved

9AKK106417 EN 2015-12